

## SERVICE MANUAL

# AIR-CONDITIONER

## MULTI-SPLIT TYPE

### Indoor unit

#### *For R410A:*

**RAS-M07G3DV-E**

**RAS-M10G3DV-E**

**RAS-M13G3DV-E**

**RAS-M16G3DV-E**

**RAS-M07G3DV-ND**

**RAS-M10G3DV-ND**

**RAS-M13G3DV-ND**

**RAS-M16G3DV-ND**

**RAS-M07G3DV-TR**

**RAS-M10G3DV-TR**

**RAS-M13G3DV-TR**

**RAS-M16G3DV-TR**

#### *For R32 or R410A:*

**RAS-M07U2DVG-E**

**RAS-M10U2DVG-E**

**RAS-M13U2DVG-E**

**RAS-M16U2DVG-E**

**RAS-M22U2DVG-E**

**RAS-M24U2DVG-E**

**RAS-M07U2DVG-TR**

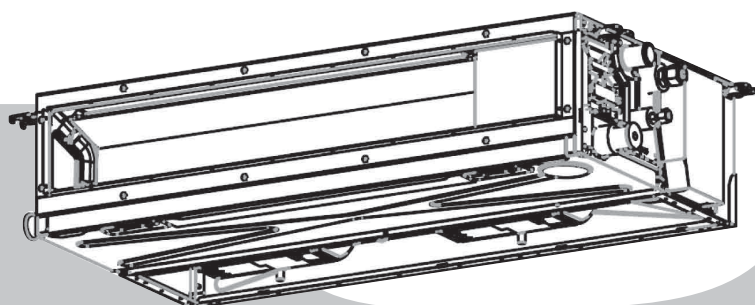
**RAS-M10U2DVG-TR**

**RAS-M13U2DVG-TR**

**RAS-M16U2DVG-TR**

**RAS-M22U2DVG-TR**

**RAS-M24U2DVG-TR**






# CONTENTS

1. SAFETY PRECAUTIONS.....	2
2. SPECIFICATIONS .....	10
3. REFRIGERANT R410A AND R32.....	12
4. CONSTRUCTION VIEWS.....	24
5. WIRING DIAGRAM.....	25
6. SPECIFICATIONS OF ELECTRICAL PARTS .....	26
7. REFRIGERANT CYCLE DIAGRAM.....	27
8. CONTROL BLOCK DIAGRAM .....	28
9. OPERATION DESCRIPTION .....	29
10. OWNER'S MANUAL AND INSTALLATION MANUAL (EXCERPT) .....	55
11. HOW TO DIAGNOSE THE TROUBLE.....	73
12. HOW TO REPLACE THE MAIN PARTS.....	87
13. EXPLODED VIEWS AND PARTS LIST .....	97
14. APPENDIX.....	102

# 1.SAFETY PRECAUTIONS




The important contents concerned to the safety are described on the product itself and on this Service Manual. Please read this Service Manual after understanding the described items thoroughly in the following contents (Indications / Illustrated marks), and keep them.

## [Explanation of indications]

Indication	Explanation
 <b>DANGER</b>	Indicates contents assumed that an imminent danger causing a death or serious injury of the repair engineers and the third parties when an incorrect work has been executed.
 <b>WARNING</b>	Indicates possibilities assumed that a danger causing a death or serious injury of the repair engineers, the third parties, and the users due to troubles of the product after work when an incorrect work has been executed.
 <b>CAUTION</b>	Indicates contents assumed that an injury or property damage (*) may be caused on the repair engineers, the third parties, and the users due to troubles of the product after work when an incorrect work has been executed.

\* Property damage: Enlarged damage concerned to property, furniture, and domestic animal / pet

## [Explanation of illustrated marks]

Mark	Explanation
	Indicates prohibited items (Forbidden items to do) The sentences near an illustrated mark describe the concrete prohibited contents.
	Indicates mandatory items (Compulsory items to do) The sentences near an illustrated mark describe the concrete mandatory contents.
	Indicates cautions (Including danger / warning) The sentences or illustration near or in an illustrated mark describe the concrete cautious contents.

## For general public use






Power supply cord of outdoor unit shall be more than 2.5 mm<sup>2</sup> (H07RN-F or 60245IEC66) polychloroprene sheathed flexible cord.

- Read this “Safety precautions” carefully before servicing.
- The precautions described below include the important items regarding safety. Observe them without fail.
- After the servicing work, perform a test run to check for any problem.
- Turn off the main power supply switch (or breaker) before the unit maintenance.

## Warning Indications on the Air Conditioner Unit

### [Confirmation of warning label on the main unit]

Confirm that labels are indicated on the specified positions  
If removing the label during parts replace, stick it as the original.




Warning indication		Description
	<p><b>WARNING</b></p> <p><b>ELECTRICAL SHOCK HAZARD</b> Disconnect all remote electric power supplies before servicing.</p>	<p><b>WARNING</b></p> <p><b>ELECTRICAL SHOCK HAZARD</b> Disconnect all remote electric power supplies before servicing.</p>
	<p><b>WARNING</b></p> <p>Moving parts. Do not operate unit with grille removed. Stop the unit before the servicing.</p>	<p><b>WARNING</b></p> <p>Moving parts. Do not operate unit with grille removed. Stop the unit before the servicing.</p>
	<p><b>CAUTION</b></p> <p>High temperature parts. You might get burned when removing this panel.</p>	<p><b>CAUTION</b></p> <p>High temperature parts. You might get burned when removing this panel.</p>
	<p><b>CAUTION</b></p> <p>Do not touch the aluminum fins of the unit. Doing so may result in injury.</p>	<p><b>CAUTION</b></p> <p>Do not touch the aluminium fins of the unit. Doing so may result in injury.</p>
	<p><b>CAUTION</b></p> <p><b>BURST HAZARD</b> Open the service valves before the operation, otherwise there might be the burst.</p>	<p><b>CAUTION</b></p> <p><b>BURST HAZARD</b> Open the service valves before the operation, otherwise there might be the burst.</p>





# Precaution for Safety









The appliance shall be installed in accordance with national wiring regulations. Capacity shortages of the power circuit or an incomplete installation may cause an electric shock or fire.





## DANGER







 Turn off braeaker.	<p>Before carrying out the installation, maintenance, repair or removal work, be sure to set the circuit breaker to the OFF position. Otherwise, electric shocks may result.</p>
	<p>Before opening the intake grille of the indoor unit or service panel of the outdoor unit, set the circuit breaker to the OFF position. Failure to set the circuit breaker to the OFF position may result in electric shocks through contact with the interior parts.            Only a qualified installer (*1) or qualified service person (*1) is allowed to remove the intake grille of the indoor unit or service panel of the outdoor unit and do the work required.</p>
	<p>Before opening the electric cover set the circuit breaker to the OFF position. Failure to set the circuit breaker to the OFF position may result in injury through contact with the rotation parts.</p>
	<p>When cleaning the filter or other parts of the indoor unit, set the circuit breaker to OFF without fail, and place a "Work in progress" sign near the circuit breaker before proceeding with the work.</p>
	<p>When you have noticed that some kind of trouble (such as when a check code display has appeared, there is a smell of burning, abnormal sounds are heard, the air conditioner fails to cool or heat or water is leaking) has occurred in the air conditioner, do not touch the air conditioner yourself but set the circuit breaker to the OFF position, and contact a qualified service person. Take steps to ensure that the power will not be turned on (by marking "out of service" near the circuit breaker, for instance) until qualified service person arrives. Continuing to use the air conditioner in the trouble status may cause mechanical problems to escalate or result in electric shocks or other failure.</p>
 Electric shock hazard.	<p>When checking the electric parts, removing the cover of the electric parts box of Indoor Unit and/or service panel of Outdoor Unit inevitably to determine the failure, use gloves to provide protection for electricians, insulating shoes, clothing to provide protection from electric shock and insulating tools. Be careful not to touch the live part. Electric shock may result. Only "Qualified service person" is allowed to do this work.</p>
 Prohibition	<p>Do not turn ON the circuit breaker under the condition of removing a cabinet, a panel, etc. Otherwise, it leads to an electric shock with a high voltage, resulting in loss of life.</p>





 **WARNIG**

 General	<p>Before starting to repair the air conditioner, read carefully through the Service Manual, and repair the air conditioner by following its instructions.</p>
	<p>Only qualified service person (*1) is allowed to repair the air conditioner. Repair of the air conditioner by unqualified person may give rise to a fire, electric shocks, injury, water leaks and/or other problems.</p>
	<p>Only a qualified installer (*1) or qualified service person (*1) is allowed to carry out the electrical work of the air conditioner. Under no circumstances must this work be done by an unqualified individual since failure to carry out the work properly may result in electric shocks and/or electrical leaks.</p>
	<p>Wear protective gloves and safety work clothing during installation, servicing and removal.</p>
	<p>Do not use any refrigerant different from the one specified for complement or replacement. Otherwise, abnormally high pressure may be generated in the refrigeration cycle, which may result in a failure or explosion of the product or an injury to your body.</p>
	<p>When connecting the electrical wires, repairing the electrical parts or undertaking other electrical jobs, wear gloves to provide protection for electricians, insulating shoes and clothing to provide protection from electric shocks. Failure to wear this protective gear may result in electric shocks.</p>
	<p>When the air conditioner is to be transported, installed, maintained, repaired or removed, wear protective gloves and 'safety' work clothing.</p>
	<p>To connect the electrical wires, repair the electrical parts or undertake other electrical jobs, wear gloves to provide protection for electricians, insulating shoes and clothing to provide protection from electric shocks. Failure to wear this protective gear may result in electric shocks.</p>
	<p>Electrical wiring work shall be conducted according to law and regulation in the community and installation manual. Failure to do so may result in electrocution or short circuit.</p>
	<p>Use wiring that meets the specifications in the Installation Manual and the stipulations in the local regulations and laws. Use of wiring which does not meet the specifications may give rise to electric shocks, electrical leakage, smoking and/or a fire.</p>
	<p>Only a qualified installer (*1) or qualified service person (*1) is allowed to undertake work at heights using a stand of 50 cm or more.</p>
	<p>When working at heights, use a ladder which complies with the ISO 14122 standard, and follow the procedure in the ladder's instructions. Also wear a helmet for use in industry as protective gear to undertake the work.</p>
	<p>When working at heights, put a sign in place so that no-one will approach the work location, before proceeding with the work. Parts and other objects may fall from above, possibly injuring a person below.</p>
	<p>When executing address setting, test run, or troubleshooting through the checking window on the electric parts box, put on insulated gloves to provide protection from electric shock. Otherwise you may receive an electric shock.</p>
	<p>Do not touch the aluminum fin of the outdoor unit. You may injure yourself if you do so. If the fin must be touched for some reason, first put on protective gloves and safety work clothing, and then proceed.</p>
	<p>Do not climb onto or place objects on top of the outdoor unit. You may fall or the objects may fall off of the outdoor unit and result in injury.</p>
	<p>When transporting the air conditioner, wear shoes with additional protective toe caps.</p>
<p>When transporting the air conditioner, do not take hold of the bands around the packing carton. You may injure yourself if the bands should break.</p>	
<p>Be sure that a heavy unit (10 kg or heavier) such as a compressor is carried by four persons.</p>	
<p>This air conditioner has passed the pressure test as specified in IEC 60335-2-40 Annex EE.</p>	
 Electric shock hazard	<p>When you access inside of the electric cover to repair electric parts, wait for about five minutes after turning off the breaker. Do not start repairing immediately. Otherwise you may get electric shock by touching terminals of high-voltage capacitors. Natural discharge of the capacitor takes about five minutes.</p>



 Prohibition	Place a "Work in progress" sign near the circuit breaker while the installation, maintenance, repair or removal work is being carried out. There is a danger of electric shocks if the circuit breaker is set to ON by mistake.
	When checking the electric parts, removing the cover of the electric parts box of Indoor Unit and/or front panel of Outdoor Unit inevitably to determine the failure, put a sign "Do not enter" around the site before the work. Failure to do this may result in third person getting electric shock.
	Before operating the air conditioner after having completed the work, check that the electrical parts box cover of the indoor unit and service panel of the outdoor unit are closed, and set the circuit breaker to the ON position. You may receive an electric shock if the power is turned on without first conducting these checks.
 Stay on protection	<p>If, in the course of carrying out repairs, it becomes absolutely necessary to check out the electrical parts with the electrical parts box cover of one or more of the indoor units and the service panel of the outdoor unit removed in order to find out exactly where the trouble lies, wear insulated heat-resistant gloves, insulated boots and insulated work overalls, and take care to avoid touching any live parts. You may receive an electric shock if you fail to heed this warning.</p> <p>Only qualified service person (*1) is allowed to do this kind of work.</p>
 Check earth wires.	<p>Before troubleshooting or repair work, check the earth wire is connected to the earth terminals of the main unit, otherwise an electric shock is caused when a leak occurs. If the earth wire is not correctly connected, contact an electric engineer for rework.</p>
	<p>After completing the repair or relocation work, check that the ground wires are connected properly.</p> <p>Be sure to connect earth wire. (Grounding work) Incomplete grounding causes an electric shock. Do not connect ground wires to gas pipes, water pipes, and lightning rods or ground wires for telephone wires.</p>
 Prohibition of modification.	<p>Do not modify the products. Do not also disassemble or modify the parts. It may cause a fire, electric shock or injury.</p>
 Use specified parts.	<p>When any of the electrical parts are to be replaced, ensure that the replacement parts satisfy the specifications given in the Service Manual (or use the parts contained on the parts list in the Service Manual). Use of any parts which do not satisfy the required specifications may give rise to electric shocks, smoking and/or a fire.</p>
	<p>Replace components only with parts specified by the manufacturer. Other parts may result in the ignition of refrigerant in the atmosphere from a leak.</p>
 Do not bring a child close to the equipment.	<p>If, in the course of carrying out repairs, it becomes absolutely necessary to check out the electrical parts with the electrical parts box cover of one or more of the indoor units and the service panel of the outdoor unit removed in order to find out exactly where the trouble lies, place Keep out signs around the work site before proceeding. Third-party individuals may enter the work site and receive electric shocks if this warning is not heeded.</p>
 Insulating measures	<p>Connect the cut-off lead wires with crimp contact, etc., put the closed end side upward and then apply a water-cut method, otherwise a leak or production of fire is caused at the users' side.</p>
	<p>Under no circumstances, the power supply wire or the indoor and outdoor connecting wire must not be connected in the middle (Connection using a solder less terminal etc.)  Connection trouble in the places where the wire is connected in the middle may give rise to smoking and/or a fire.</p>
 No fire	<p>When performing repairs using a gas burner, replace the refrigerant with nitrogen gas because the oil that coats the pipes may otherwise burn.</p> <p>When repairing the refrigerating cycle, take the following measures.</p> <ol style="list-style-type: none"> <li>1) Be attentive to fire around the cycle.  When using a gas stove, etc., be sure to put out fire before work; otherwise the oil mixed with refrigerant gas may catch fire.</li> <li>2) Do not use a welder in the closed room.  When using it without ventilation, carbon monoxide poisoning may be caused.</li> <li>3) Do not bring inflammables close to the refrigerant cycle, otherwise fire of the welder may catch the inflammables.</li> </ol>

 Refrigerant	<p>The refrigerant used by this air conditioner is the R32/R410A.(R32 for some model only).</p>
	<p>Check the used refrigerant name and use tools and materials of the parts which match with it.            For the products which use R32/R410A refrigerant, the refrigerant name is indicated at a position on the outdoor unit where is easy to see. To prevent miss-charging, the route of the service port is changed from one of the former R22.            Be careful for miss-charging since a charging port of R32 is the same diameter as that of R410A.</p>
	<p>Do not use any refrigerant different from the one specified for complement or replacement.            Otherwise, abnormally high pressure may be generated in the refrigeration cycle, which may result in a failure or explosion of the product or an injury to your body.</p>
	<p>For an air conditioner which uses R32, never use other refrigerant than R32.            For an air conditioner which uses other refrigerant (R22, R410A etc.), never use R32.            If different types of refrigerant are mixed, abnormal high pressure generates in the refrigerating cycle and an injury due to breakage may be caused.            If the different type of refrigerants are mixed in, be sure to recharge the refrigerant</p>
	<p>When the air conditioner has been installed or relocated, follow the instructions in the Installation Manual and purge the air completely so that no gases other than the refrigerant will be mixed in the refrigerating cycle. Failure to purge the air completely may cause the air conditioner to malfunction.</p>
	<p>Do not charge refrigerant additionally.            If charging refrigerant additionally when refrigerant gas leaks, the refrigerant composition in the refrigerating cycle changes resulted in change of air conditioner characteristics or refrigerant over the specified standard amount is charged and an abnormal high pressure is applied to the inside of the refrigerating cycle resulted in cause of breakage or injury. Therefore if the refrigerant gas leaks, recover the refrigerant in the air conditioner, execute vacuuming, and then newly recharge the specified amount of liquid refrigerant. In this time, never charge the refrigerant over the specified amount.</p>
	<p>When recharging the refrigerant in the refrigerating cycle, do not mix the refrigerant or air into the specified refrigerant. If air or others is mixed with the refrigerant, abnormal high pressure generates in the refrigerating cycle resulted in cause of injury due to breakage.</p>
	<p>After the installation work, confirm that refrigerant gas does not leak. If refrigerant gas leaks into the room and flows near a fire source, such as a cooking range, it may generate noxious gases, causing a fire.</p> <p>Never recover the refrigerant into the outdoor unit.            When the equipment is moved or repaired, be sure to recover the refrigerant with recovering device. The refrigerant cannot be recovered in the outdoor unit; otherwise a serious accident such as breakage or injury is caused.</p>
 Assembly/ Wiring	<p>After repair work, surely assemble the disassembled parts, and connect and lead the removed wires as before. Perform the work so that the cabinet or panel does not catch the inner wires.            If incorrect assembly or incorrect wire connection was done, a disaster such as a leak or fire is caused at user's side.</p>
 Insulator check	<p>After the work has finished, be sure to use an insulation tester set (500V Megger) to check the resistance is 1MΩ or more between the charge section and the non-charge metal section (Earth position). If the resistance value is low, a disaster such as a leak or electric shock is caused at user's side.</p>
 Ventilation	<p>When the refrigerant gas leaks during work, execute ventilation.            If the refrigerant gas touches to a fire, it may generate noxious gases, causing a fire.            A case of leakage of the refrigerant and the closed room full with gas is dangerous because a shortage of oxygen occurs. Be sure to execute ventilation.</p>
	<p>If refrigerant gas has leaked during the installation work, ventilate the room immediately.            If the leaked refrigerant gas comes in contact with fire, it may generate noxious gases, causing a fire.</p>

 Compulsion	<p>When the refrigerant gas leaks, find up the leaked position and repair it surely.  If the leaked position cannot be found up and the repair work is interrupted, pump-down and tighten the service valve, otherwise the refrigerant gas may leak into the room.  When gas touches to fire such as fan heater, stove or cooking stove, it may generate noxious gases, causing a fire though the refrigerant gas itself is innocuous.  When installing equipment which includes a large amount of charged refrigerant such as a multi air conditioner in a sub-room, it is necessary that the density does not the limit even if the refrigerant leaks. If the refrigerant leaks and exceeds the limit density, an accident of shortage of oxygen is caused.</p>
	<p>Tighten the flare nut with a torque wrench in the specified manner.  Excessive tighten of the flare nut may cause a crack in the flare nut after a long period, which may result in refrigerant leakage.</p>
	<p>Nitrogen gas must be used for the airtight test.</p>
	<p>The charge hose must be connected in such a way that it is not slack.</p>
	<p>For the installation/moving/reinstallation work, follow to the Installation Manual.  If an incorrect installation is done, a trouble of the refrigerating cycle, water leak, electric shock or fire is caused.</p>
<p>Install the outdoor unit properly in a location that is durable enough to support the weight of the outdoor unit. Insufficient durability may cause the outdoor unit to fall, which may result in injury.</p>	
 Check after repair	<p>Once the repair work has been completed, check for refrigerant leaks, and check the insulation resistance and water drainage. Then perform a trial run to check that the air conditioner is running properly.</p>
	<p>After repair work has finished, check there is no trouble. If check is not executed, a fire, electric shock or injury may be caused. For a check, turn off the power breaker.</p>
	<p>After repair work (installation of front panel and cabinet) has finished, execute a test run to check there is no generation of smoke or abnormal sound. If check is not executed, a fire or an electric shock is caused. Before test run, install the front panel and cabinet.</p>
<p>Be sure to fix the screws back which have been removed for installation or other purposes.</p>	
 Do not operate the unit with the valve closed.	<p>Check the following matters before a test run after repairing piping.</p> <ul style="list-style-type: none"> <li>• Connect the pipes surely and there is no leak of refrigerant.</li> <li>• The valve is opened.</li> </ul> <p>Running the compressor under condition that the valve closes causes an abnormal high pressure resulted in damage of the parts of the compressor and etc. and moreover if there is leak of refrigerant at connecting section of pipes, the air is suctioned and causes further abnormal high pressure resulted in burst or injury.</p>
 Check after reinstallation	<p>Only a qualified installer (*1) or qualified service person (*1) is allowed to relocate the air conditioner. It is dangerous for the air conditioner to be relocated by an unqualified individual since a fire, electric shocks, injury, water leakage, noise and/or vibration may result.</p>
	<p>Check the following items after reinstallation.</p> <ol style="list-style-type: none"> <li>1) The earth wire is correctly connected.</li> <li>2) The power cord is not caught in the product.</li> <li>3) There is no inclination or unsteadiness and the installation is stable.</li> </ol> <p>If check is not executed, a fire, an electric shock or an injury is caused.</p>
 Cooling check	<p>When the service panel of the outdoor unit is to be opened in order for the compressor or the area around this part to be repaired immediately after the air conditioner has been shut down, set the circuit breaker to the OFF position, and then wait at least 10 minutes before opening the service panel. If you fail to heed this warning, you will run the risk of burning yourself because the compressor pipes and other parts will be very hot to the touch. In addition, before proceeding with the repair work, wear the kind of insulated heat-resistant gloves designed to protect electricians.</p>
	<p>When the service panel of the outdoor unit is to be opened in order for the fan motor, reactor, inverter or the areas around these parts to be repaired immediately after the air conditioner has been shut down, set the circuit breaker to the OFF position, and then wait at least 10 minutes before opening the service panel. If you fail to heed this warning, you will run the risk of burning yourself because the fan motor, reactor, inverter heat sink and other parts will be very hot to the touch. In addition, before proceeding with the repair work, wear the kind of insulated heat-resistant gloves designed to protect electricians.</p>
 Cooling	<p>Take care not to get burned by compressor pipes or other parts when checking the cooling cycle while running the unit as they get heated while running. Be sure to put on gloves providing protection for heat.</p>

 Installation	<p>Only a qualified installer (*1) or qualified service person (*1) is allowed to install the air conditioner. If the air conditioner is installed by an unqualified individual, a fire, electric shocks, injury, water leakage, noise and/or vibration may result.</p>
	<p>Before starting to install the air conditioner, read carefully through the Installation Manual, and follow its instructions to install the air conditioner.</p>
	<p>Be sure to use the company-specified products for the separately purchased parts. Use of no specified products may result in fire, electric shock, water leakage or other failure. Have the installation performed by a qualified installer.</p>
	<p>Do not supply power from the power terminal block equipped on the outdoor unit to another outdoor unit. Capacity overflow may occur on the terminal block and may result in fire.</p>
	<p>Do not install the air conditioner in a location that may be subject to a risk of expire to a combustible gas. If a combustible gas leaks and becomes concentrated around the unit, a fire may occur.</p>
	<p>Install the indoor unit at least 2.5 m above the floor level since otherwise the users may injure themselves or receive electric shocks if they poke their fingers or other objects into the indoor unit while the air conditioner is running.</p>
	<p>Install a circuit breaker that meets the specifications in the installation manual and the stipulations in the local regulations and laws.</p>
	<p>When transporting the air conditioner, use a forklift and when moving the air conditioner by hand, move the unit with 4 people.</p>
	<p>Install a circuit breaker that meets the specifications in the installation manual and the stipulations in the local regulations and laws.</p>
	<p>Install the circuit breaker where it can be easily accessed by the agent.</p>
 Compulsion	<p>If you install the unit in a small room, take appropriate measures to prevent the refrigerant from exceeding the limit concentration even if it leaks. Consult the dealer from whom you purchased the air conditioner when you implement the measures. Accumulation of highly concentrated refrigerant may cause an oxygen deficiency accident.</p>
	<p>Do not place any combustion appliance in a place where it is directly exposed to the wind of air conditioner, otherwise it may cause imperfect combustion.</p>
 Compulsion	<p>When carrying out the pump-down work shut down the compressor before disconnecting the refrigerant pipe. Disconnecting the refrigerant pipe with the service valve left open and the compressor still operating will cause air, etc. to be sucked in, raising the pressure inside the refrigeration cycle to an abnormally high level, and possibly resulting in reputing, injury, etc.</p>
	<p>When removing the welding parts of suction and discharge pipe for the compressor, remove them at the place ventilated well after recovering the refrigerant. Improper recovering may cause the spurt of the refrigerant and the refrigeration oil, causing an injury.</p>
 Prohibition	<p>Do not vent gases to the atmosphere. Venting gases to the atmosphere is prohibited by the law.</p>

## CAUTION

 Wearing of gloves	<p>Ensure wearing of gloves when performing any work in order to avoid injury from parts, etc. Failure to wear the proper protective gloves cause a injury due to the parts, etc.</p>
 Confirm	<p>When performing the welding work, check whether refrigerant leaks or remains. If the leakage refrigerant gas touches a fire source, it may generate noxious gases, causing a fire.</p>

## 2. SPECIFICATIONS

Model Name		RAS-M07U2DVG-E				RAS-M10U2DVG-E				RAS-M13U2DVG-E				RAS-M16U2DVG-E					
		RAS-M07U2DVG-TR				RAS-M10U2DVG-TR				RAS-M13U2DVG-TR				RAS-M16U2DVG-TR					
		RAS-M07G3DV-E				RAS-M10G3DV-E				RAS-M13G3DV-E				RAS-M16G3DV-E					
		RAS-M07G3DV-ND				RAS-M10G3DV-ND				RAS-M13G3DV-ND				RAS-M16G3DV-ND					
		RAS-M07G3DV-TR				RAS-M10G3DV-TR				RAS-M13G3DV-TR				RAS-M16G3DV-TR					
Cooling capacity (Rated) [kW]		2.0				2.7				3.7				4.5					
Cooling Capacity range [kW]		*1				*1				*1				*1					
Heating Capacity (Rated) [kW]		2.7				4.0				5.0				5.5					
Heating Capacity range [kW]		*1				*1				*1				*1					
Power supply		1Phase, 50Hz, 220-240V / 1Phase, 60Hz, 220V																	
Electric characteristics *2	Voltage [V]	220	230	240	220	230	240	220	230	240	220	230	240	220	230	240			
	Running current [A]	0.35	0.34	0.32	0.35	0.34	0.32	0.40	0.38	0.36	0.45	0.43	0.42						
	Power Consumption [W]	48				48				54				62					
	Power Factor [%]	62				62				62				62					
Electric characteristics in NP *3	Maximum current [A]	0.6				0.6				0.6				0.8					
	Maximum power input [W]	80				80				80				100					
External Static Pressure Setting		4steps (10 / 20 / 35 / 45)																	
		10Pa	20Pa	35Pa	45Pa	10Pa	20Pa	35Pa	45Pa	10Pa	20Pa	35Pa	45Pa	10Pa	20Pa	35Pa	45Pa		
Air flow [m3/h] *4	Cooling	HH	570				570				610				780				
		H+	525				525				555				720	670	690	690	
		H	475				475				500				580	540	590	600	
		L+	430				430				440				500	490	490	560	
		L	380				380				385				420				
	Heating	HH	570				570				610				780				
		H+	525				525				555				720	670	690	690	
		H	475				475				500				580	540	590	600	
		L+	430				430				440				510	490	490	560	
		L	380				380				385				450				
Sound pressure level [dBA] *5	Back air intake *6	Cooling	HH	33	34	35	36	33	34	35	36	35	36	37	38	33	34	35	36
			H+	31	32	33	34	31	32	33	34	32	33	34	35	31	31	32	33
			H	29	30	31	32	29	30	31	32	29	30	31	32	27	27	29	31
			L+	27	28	29	30	27	28	29	30	27	28	29	30	24	25	26	29
			L	25	26	27	28	25	26	27	28	25	26	27	28	22	23	24	25
		Heating	HH	33	34	35	36	33	34	35	36	35	36	37	38	33	34	35	36
			H+	31	32	33	34	31	32	33	34	32	33	34	35	31	31	32	33
			H	29	30	31	32	29	30	31	32	29	30	31	32	27	27	29	31
			L+	27	28	29	30	27	28	29	30	27	28	29	30	25	25	26	29
			L	25	26	27	28	25	26	27	28	25	26	27	28	23	24	25	26
	Under air intake *7	Cooling	HH	41	42	43	44	41	42	43	44	43	44	45	46	41	42	43	44
			H+	38	39	40	41	38	39	40	41	39	40	41	42	39	39	40	41
			H	35	36	37	38	35	36	37	38	36	37	38	39	34	34	36	38
			L+	33	34	35	36	33	34	35	36	33	34	35	36	31	32	33	36
			L	30	31	32	33	30	31	32	33	30	31	32	33	27	28	29	30
		Heating	HH	41	42	43	44	41	42	43	44	43	44	45	46	41	42	43	44
			H+	38	39	40	41	38	39	40	41	39	40	41	42	39	39	40	41
			H	35	36	37	38	35	36	37	38	36	37	38	39	34	34	36	38
			L+	33	34	35	36	33	34	35	36	33	34	35	36	32	32	33	36
			L	30	31	32	33	30	31	32	33	30	31	32	33	28	29	30	31
Fan Unit	Fan	centrifugal fan																	
	Motor Output [W]	50												94					
Dimensions *8	Height [mm]	210																	
	Width [mm]	700												900					
	Depth [mm]	450																	
Net weight [kg]		16												19					
Piping connection	Type	Flare connection																	
	Liquid side [mm]	Φ6.35																	
	Gas side [mm]	Φ9.52												Φ12.7					
	Drain port	VP25																	
Usable indoor temperature range (Cooling / Heating)		21~32°C / 0~28°C																	
Refrigerant	R410A	RAS-M***G3DV*																	
	R32 or R410A	RAS-M**U2DVG*																	

\*1 ... Refer to the service manual of the outdoor unit to be combined.

\*2 ... Electrical characteristics is under FAN ONLY mode HH tap at 35Pa. (M07, 10, 13, 16 type at 35Pa, M22, 24 type at 10Pa)

\*3 ... Electrical characteristics in NP is under maximum load condition.

\*4 ... Air Flow is under standard external static pressure line at each pressure setting.

\*5 ... Sound power level = Sound pressure level + 15 [dBA]

\*6 ... Measuring condition of sound pressure level with back air intake:

Air discharge duct length= 2m, air suction duct length=1m, position of sound pressure level measurement is at 1.4m below the product.

\*7 ... Measuring condition of sound pressure level with under air intake:

Air discharge duct length= 2m, air suction duct is not attached, position of sound pressure level measurement is at 1.4m below the product.

\*8 ... Unit external dimensions (except hanging hook)

Model Name		RAS-M22U2DVG-E				RAS-M24U2DVG-E						
		RAS-M22U2DVG-TR				RAS-M24U2DVG-TR						
Cooling capacity (Rated) [kW]		6.0				7.1						
Cooling Capacity range [kW]		*1				*1						
Heating Capacity (Rated) [kW]		7.0				8.1						
Heating Capacity range [kW]		*1				*1						
Power supply		1Phase, 50Hz, 220-240V / 1Phase, 60Hz, 220V										
Electric characteristics in usual use *2	Voltage [V]	220	230	240	220	230	240					
	Running current [A]	0.49	0.47	0.45	0.54	0.52	0.49					
	Power Consumption [W]	69				76						
	Power Factor [%]	64				64						
Electric characteristics in NP *3	Maximum current [A]	0.9				0.9						
	Maximum power input [W]	114				119						
External Static Pressure Setting		4steps (10 / 20 / 35 / 45)										
		10Pa	20Pa	35Pa	45Pa	10Pa	20Pa	35Pa	45Pa			
Air flow [m3/h] *4	Cooling	HH	1000				1060					
		H+	940				990					
		H	870				910					
		L+	810				840					
		L	740				760					
		Heating	HH	1000				1060				
	H+		940				990					
	H		870				910					
	L+		810				840					
	L		740				760					
	Sound pressure level [dBA] *5		Back air intake *6	Cooling	HH	37	37	38	38	38	38	39
		H+			36	36	37	37	36	37	37	37
H		33			34	35	36	34	35	36	36	37
L+		32			32	34	34	33	33	34	34	35
L		30			31	32	32	31	32	33	33	34
Heating		HH			37	37	38	38	38	38	39	39
		H+		36	36	37	37	36	37	37	37	39
		H		33	34	35	36	34	35	36	36	37
		L+		32	32	34	34	33	33	34	34	35
		L		30	31	32	32	31	32	33	33	34
		Under air intake *7		Cooling	HH	43	44	45	45	45	45	46
H+					42	43	44	44	44	43	44	46
H			40		41	42	42	41	42	42	44	
L+			38		39	40	41	39	40	41	42	
L			37		38	39	40	38	38	40	41	
Heating			HH		43	44	45	45	45	45	46	46
			H+	42	43	44	44	44	43	44	46	
			H	40	41	42	42	41	42	42	44	
			L+	38	39	40	41	39	40	41	42	
			L	37	38	39	40	38	38	40	41	
			Fan Unit	Fan	centrifugal fan							
			Motor Output [W]	94								
Dimensions *8		Height [mm]	210									
		Width [mm]	1100									
	Depth [mm]	450										
Net weight [kg]	22											
Piping connection	Type	Flare connection										
	Liquid side [mm]	Φ6.35										
	Gas side [mm]	Φ12.7										
	Drain port	VP25										
Usable indoor temperature range (Cooling / Heating)	21~32°C / 0~28°C											
Refrigerant	R410A	RAS-M***G3DV*										
	R32 or R410A	RAS-M**U2DVG*										

\*1 ... Refer to the service manual of the outdoor unit to be combined.

\*2 ... Electrical characteristics in usual use is under FAN ONLY mode HH tap at 10Pa. (M07, 10, 13, 16 type at 35Pa, M22, 24 type at 10Pa)

\*3 ... Electrical characteristics in NP is under maximum load condition.

\*4 ... Air Flow is under standard external static pressure line at each pressure setting.

\*5 ... Sound power level = Sound pressure level + 15 [dBA]

\*6 ... Measuring condition of sound pressure level with back air intake:

Air discharge duct length= 2m, air suction duct length=1m, position of sound pressure level measurement is at 1.4m below the product.

\*7 ... Measuring condition of sound pressure level with under air intake:

Air discharge duct length= 2m, air suction duct is not attached, position of sound pressure level measurement is at 1.4m below the product.

\*8 ... Unit external dimensions (except hanging hook)



### 3. REFRIGERANT R410A AND R32

#### Refrigerant R410A

This air conditioner adopts the new refrigerant HFC (R410A) which does not damage the ozone layer.

The working pressure of the new refrigerant R410A is 1.6 times higher than conventional refrigerant (R22). The refrigerating oil is also changed in accordance with change of refrigerant, so be careful that water, dust, and existing refrigerant or refrigerating oil are not entered in the refrigerant cycle of the air conditioner using the new refrigerant during installation work or servicing time.

The next section describes the precautions for air conditioner using the new refrigerant. Conforming to contents of the next section together with the general cautions included in this manual, perform the correct and safe work.

#### 3-1. Safety During Installation/Service

As R410A's pressure is about 1.6 times higher than that of R22, improper installation/servicing may cause a serious trouble. By using tools and materials exclusive for R410A, it is necessary to carry out installation/servicing safely while taking the following precautions into consideration.

1. Never use refrigerant other than R410A in an air conditioner which is designed to operate with R410A.  
If other refrigerant than R410A is mixed, pressure in the refrigeration cycle becomes abnormally high, and it may cause personal injury, etc. by a rupture.
2. Confirm the used refrigerant name, and use tools and materials exclusive for the refrigerant R410A.  
The refrigerant name R410A is indicated on the visible place of the outdoor unit of the air conditioner using R410A as refrigerant. To prevent mischarging, the diameter of the service port differs from that of R22.
3. If a refrigeration gas leakage occurs during installation/servicing, be sure to ventilate fully.  
If the refrigerant gas comes into contact with fire, a poisonous gas may occur.
4. When installing or removing an air conditioner, do not allow air or moisture to remain in the refrigeration cycle. Otherwise, pressure in the refrigeration cycle may become abnormally high so that a rupture or personal injury may be caused.
5. After completion of installation work, check to make sure that there is no refrigeration gas leakage.  
If the refrigerant gas leaks into the room, coming into contact with fire in the fan-driven heater, space heater, etc., a poisonous gas may occur.
6. When an air conditioning system charged with a large volume of refrigerant is installed in a small room, it is necessary to exercise care so that, even when refrigerant leaks, its concentration does not exceed the marginal level.  
If the refrigerant gas leakage occurs and its concentration exceeds the marginal level, an oxygen starvation accident may result.

7. Be sure to carry out installation or removal according to the installation manual.  
Improper installation may cause refrigeration trouble, water leakage, electric shock, fire, etc.
8. Unauthorized modifications to the air conditioner may be dangerous. If a breakdown occurs please call a qualified air conditioner technician or electrician.  
Improper repair's may result in water leakage, electric shock and fire, etc.

#### 3-2. Refrigerant Piping Installation

##### 3-2-1. Piping Materials and Joints Used

For the refrigerant piping installation, copper pipes and joints are mainly used. Copper pipes and joints suitable for the refrigerant must be chosen and installed. Furthermore, it is necessary to use clean copper pipes and joints whose interior surfaces are less affected by contaminants.

##### 1. Copper Pipes

It is necessary to use seamless copper pipes which are made of either copper or copper alloy and it is desirable that the amount of residual oil is less than 40 mg/10 m. Do not use copper pipes having a collapsed, deformed or discolored portion (especially on the interior surface).

Otherwise, the expansion valve or capillary tube may become blocked with contaminants.

As an air conditioner using R410A incurs pressure higher than when using R22, it is necessary to choose adequate materials.

Thicknesses of copper pipes used with R410A are as shown in Table 3-2-1. Never use copper pipes thinner than 0.8 mm even when it is available on the market.

#### Refrigerant R32

This air conditioner adopts a new HFC type refrigerant (R32) which does not deplete the ozone layer.

##### 1. Safety Caution Concerned to Refrigerant R32

Be sure that water, dust, the former refrigerant or the former refrigerating oil is not mixed into the refrigerating cycle of the air conditioner with refrigerant R32 during installation work or service work.

If an incorrect work or incorrect service is performed, there is a possibility to cause a serious accident.

Use the tools and materials exclusive to R32 to purpose a safe work.

## 2. Safety and Cautions on Installation/Service

### <Safety items>

When gas concentration and ignition energy are happened at the same time, R32 has a slight possibility of burning. Although it will not ignite under normal work environment conditions, be aware that the flame spreads if ignition should occur.

It is necessary to carry out installation/servicing safely while taking the following precautions into consideration.

- 1) Never use refrigerant other than specified refrigerant (R32) in an air conditioner which is designed to operate with the specified refrigerant (R32).  
If other refrigerant than R32 is used, it may cause personal injury, etc. by a malfunction, a fire, a rupture.
- 2) Since R32 is heavier than air, it tends to accumulate on the bottom (near the floor).  
Ventilate properly for the working environment to prevent its combustion.  
Especially in a basement or a closed room where is the high risk of the accumulation, ventilate the room with a local exhaust ventilation.  
If refrigerant leakage is confirmed in the room or the place where the ventilation is insufficient, do not work until the proper ventilation is performed and the work environment is improved.
- 3) When performing brazing work, be sure to check for leakage refrigerant or residual refrigerant.  
If the leakage refrigerant comes into contact with fire, a poisonous gas may occur or it may cause a fire. Keep adequate ventilation during the work.
- 4) When refrigerant gas leaks during work, execute ventilation. If the leakage refrigerant comes into contact with a fire, a poisonous gas may occur or it may cause a fire.
- 5) In places where installing / repairing air-conditioning equipment, etc., keep the source of ignition such as gas combustion equipment, petroleum combustion equipment, electric heater etc. away. Do not smoke in the place.
- 6) When installing or removing an air conditioner, do not mix air in the refrigerant cycle.  
If air or others is mixed with the refrigerant, abnormal high pressure generates in the refrigerating cycle, causing injury due to the breakage.
- 7) After installation work complete, confirm that refrigerant gas is not leaking on the flare connection part or others. If leaked refrigerant comes to contact with a fire, toxic gas may occur, causing a fire.
- 8) Perform the installation work and re-installation according to the installation manual.  
Pay attention especially to the area of application. Improper installation may cause refrigeration trouble or water leakage, electric shock and fire etc.
- 9) Unauthorized modifications to the air conditioner may be dangerous. If a breakdown occurs please call a qualified air conditioner technician or electrician.  
Improper repair may result in water leakage, electric shock and fire, etc.

- 10) Carry out the airtight test with nitrogen at a specified pressure. Do not use oxygen or acetylene gas absolutely as it may cause an explosion.
- 11) Always carry a refrigerant leakage detection sensor during the work and work while checking that no refrigerant leaks around working environment.
- 12) If the leakage refrigerant comes into contact with fire, it may cause a fire.  
Have a dry powder or CO2 fire extinguisher adjacent to the charging area.

### <Caution items>

- 1) The opposite side dimension of the air-conditioner's flared nut using R32 and the shape of the charge port are the same as those of R410A.
- 2) Be careful not to charge refrigerant by mistake. Should the different type of refrigerant mix in, be sure to recharge the refrigerant
- 3) Do not mix the other refrigerant or refrigerating oil with the refrigerant.
- 4) Since the pressure of R32 is high 1.6 times of that of the former refrigerant (R22), use tools and parts with high pressure withstand specification similar to R410A.
- 5) In the installation time, use clean pipe materials and work with great attention so that water and others do not mix in because pipes are affected by impurities such as water, oxide film, oil, etc. Use the clean pipes. Be sure to braze while flowing nitrogen gas in the pipe. (Never use gas other than nitrogen gas.)
- 6) For the earth protection, use a vacuum pump for air purge.
- 7) R32 refrigerant is Single-component refrigerant that does not change its composition.  
Although it is possible to charge the refrigerant with either liquid or gas, charge it with liquid.  
(If using gas for charging, composition of the refrigerant changes and then characteristics of the air conditioner change.)

### 3. Pipe Materials

For the refrigerant pipes, copper pipe and joints are mainly used.

It is necessary to select the most appropriate pipes to conform to the standard.

Use clean material in which impurities adhere inside of pipe or joint to a minimum.

## 1) Copper pipe

### <Piping>

The pipe thickness, flare finishing size, flare nut and others differ according to a refrigerant type.

When using a long copper pipe for R32, it is recommended to select "Copper or copper-base pipe without seam" and one with bonded oil amount 40mg/10m or less.

Also do not use crushed, deformed, discolored (especially inside) pipes.

(Impurities cause clogging of expansion valves and capillary tubes.)

### <Flare nut>

Use the flare nuts which are attached to the air conditioner unit.

Be sure to select the pipes with copper thickness in the table below since the pressure of an air conditioner using R32 is higher than that of R22.

Nominal diameter	Outer diameter (mm)	Thickness (mm) R410A or R32
1/2	6.4	0.80
3/8	9.5	0.80
1/2	12.7	0.80
5/8	15.9	1.00

Make sure not to use a thin copper pipe such as 0.7 mm copper thickness in the market.

## 2) Joint

The flare joint and socket joint are used for joints of the copper pipe.

The joints are rarely used for installation of the air conditioner.

However clear impurities when using them.

#### 4. Tools

Tools exclusive for R32/R410A (The following tools for R32/R410A are required.)

○: R32/R410A tools available

△: Partly unavailable, ×: R32/R410A tools unavailable

No	Installation/service tools		Use	Applicability to R32/ R410A air conditioner or not	Applicability to R22 air conditioner or not
	Tools / Equipment	specification			
1	Flare tool	Clutch type	Pipe flaring	○	○
2	Copper pipe gauge for adjusting projection margin	—	Flaring by conventional flare tool	○	—
3	Torque wrench	—	Tightening of flare nut	○	×
4	Gauge manifold	Port size 1/2"- 20UNF (5/16" Flare)	Evacuating, refrigerant charge, run check, etc.	○ Note 2	×
5	Charge hose	High-voltage		○	×
6	Vacuum pump	—	Vacuum drying	○ Note 3 1/2"-20UNF(5/16" Flare)	△ Connection diameter 1/4"
7	Vacuum pump adapter	—	Vacuum drying	○ Note 4 1/2"-20UNF(5/16" Flare)	△ Connection diameter 1/4"
8	Electronic balance for refrigerant charging	For 10 kg or 20 kg cylinder	Refrigerant charge	○	○
9	Leakage detector	—	Gas leakage check	○ Note 5	○ Note 5
10	Refrigerant cylinder	—	Refrigerant charge	× Note 6	×
11	Refrigerant recovery cylinder	Exclusive for R32	Refrigerant recovery container	× Note 7	×
12	Refrigerant recovery device	—	Refrigerant recovery device	○ Note 8	△ Connection diameter 1/4"

**Note 1** When flaring is carried out for R32/R410A using the conventional flare tools, adjustment of projection margin is necessary. For this adjustment, a copper pipe gauge, etc. are necessary.

**Note 2** When saturation temperature is described, the gauge manifold differs for R410A and R32.

If saturation temperature reading is required, special tools exclusive for R32 are required.

**Note 3** Since R32 has a slight possibility of burning, be sure to use the tools corresponding to R32.

**Note 4** Like R410, a Vacuum pump adapter needs installing to prevent a Vacuum pump oil (mineral oil) from flowing backward into the Charge hose. Mixing of the Vacuum pump oil into R32 refrigerant may cause a trouble such as generation of sludge, clogging of capillary, etc.

**Note 5** Be sure to use those tools after confirming they correspond to each refrigerant.

**Note 6** For a refrigerant cylinder exclusive for R32, the paint color (or label color) of the cylinder is set to the specified color (light blue) together with the indication of the refrigerant name.

**Note 7** Although the container specification is the same as R410A, use a recovering container exclusive for R32 to avoid mixing with other refrigerants.

**Note 8** Be careful for miss-charging of the refrigerant during work. Miss-charging of the refrigerant type may cause not only damage of the equipments but also a fire etc.

## General tools

In addition to the above exclusive tools, the following equipments are necessary as the general tools.

- |                       |                             |
|-----------------------|-----------------------------|
| 1. Pipe cutter        | 6. Spanner or Monkey wrench |
| 2. Reamer             | 7. Hole core drill          |
| 3. Pipe bender        | 8. Tape measure             |
| 4. Level vial         | 9. Metal saw                |
| 5. Screwdriver (+, -) |                             |

Also prepare the following equipments for other installation method and run check.

- |                |  |
|----------------|--|
| 1. Clamp meter | 3. Insulation resistance tester (Megger) |
| 2. Thermometer | 4. Electroscop                           |

## Recovery

- When removing refrigerant from a system, either for servicing or decommissioning, it is recommended good practice that all refrigerants are removed safely.
- When transferring refrigerant into cylinders, ensure that only appropriate refrigerant recovery cylinders are employed.
- Ensure that the correct number of cylinders for holding the total system charge are available.
- All cylinders to be used are designated for the recovered refrigerant and labelled for that refrigerant (i.e. special cylinders for the recovery of refrigerant).
- Cylinders shall be complete with pressure relief valve and associated shut-off valves in good working order.
- Empty recovery cylinders are evacuated and, if possible, cooled before recovery occurs.
- The recovery equipment shall be in good working order with a set of instructions concerning the equipment that is at hand and shall be suitable for the recovery of flammable refrigerants.
- In addition, a set of calibrated weighing scales shall be available and in good working order.
- Hoses shall be complete with leak-free disconnect couplings and in good condition.
- Before using recovery machine check that it is satisfactory working order, has been properly maintained and that any associated electrical components are sealed to prevent ignition in the event of a refrigerant release.
- Consult manufacturer if in doubt.
- The recovered refrigerant shall be returned to the refrigerant supplier in the correct recovery cylinder, and the relevant Waste Transfer Note arranged.
- Do not mix refrigerants in recovery units and especially not in cylinders.
- If compressors or compressor oils are to be removed, ensure that they have been evacuated to an acceptable level to make certain that flammable refrigerant does not remain within the lubricant.
- The evacuation process shall be carried out prior to returning the compressor to the suppliers.
- Only electric heating to the compressor body shall be employed to accelerate this process.
- When oil is drained from a system, it shall be carried out safely.

## Decommissioning

- Before carrying out this procedure, it is essential that the technician is completely familiar with the equipment and all its details. Only a qualified installer (\*1) or qualified service person (\*1) is allowed to do this work.
- It is recommended good practice that all refrigerants are recovered safely.
- Prior to the task being carried out, an oil and refrigerant sample shall be taken in case analysis is required prior to re-use of reclaimed refrigerant.
- It is essential that electrical power is available before the task is commenced.

- 
- a) Become familiar with the equipment and its operation.
  - b) Isolate system electrically.
  - c) Before attempting the procedure ensure that:
    - mechanical handling equipment is available, if required, for handling refrigerant cylinders;
    - all personal protective equipment is available and being used correctly;
    - the recovery process is supervised at all times by a competent person;
    - recovery equipment and cylinders conform to the appropriate standards.
  - d) Pump down refrigerant system, if possible.
  - e) If a vacuum is not possible, make a manifold so that refrigerant can be removed from the various parts of the system.
  - f) Make sure that cylinder is situated on the scales before recovery takes place.
  - g) Start the recovery machine and operate in accordance with manufacturers instructions.
  - h) Do not overfill cylinders (No more than 80% volume liquid change).
  - i) Do not exceed the maximum working pressure of the cylinder, even temporarily.
  - j) When the cylinders have been filled correctly and the process complete, make sure that the cylinders and the equipment are removed from site promptly and all isolation valves on the equipment are closed off.
  - k) Recovered refrigerant shall not be changed into another refrigerant system unless it has been cleaned and checked.
-

**Labelling**

- Equipment shall be labelled stating that it has been de-commissioned and emptied of refrigerant.
- The label shall be dated and signed.
- Ensure that are labels on the equipment stating the equipment contains flammable refrigerant.

**Table 3-2-1 Thicknesses of annealed copper pipes**

		Thickness (mm)	
Nominal diameter	Outer diameter (mm)	R410A or R32	R22
1/4	6.35	0.80	0.80
3/8	9.52	0.80	0.80
1/2	12.70	0.80	0.80
5/8	15.88	1.00	1.00

**5. Joints**

For copper pipes, flare joints or socket joints are used. Prior to use, be sure to remove all contaminants.

a) Flare Joints

Flare joints used to connect the copper pipes cannot be used for pipings whose outer diameter exceeds 20 mm. In such a case, socket joints can be used.

Sizes of flare pipe ends, flare joint ends and flare nuts are as shown in Tables 3-2-3 to 3-2-6 below.

b) Socket Joints

Socket joints are such that they are brazed for connections, and used mainly for thick pipings whose diameter is larger than 20 mm.

Thicknesses of socket joints are as shown in Table 3-2-2.

**Table 3-2-2 Minimum thicknesses of socket joints**

Nominal diameter	Reference outer diameter of copper pipe jointed (mm)	Minimum joint thickness (mm)
1/4	6.35	0.50
3/8	9.52	0.60
1/2	12.70	0.70
5/8	15.88	0.80

**(Note 1)** When flaring is carried out for R32/R410A using the conventional flare tools, adjustment of projection margin is necessary. For this adjustment, a copper pipe gauge, etc. are necessary.

**3-2-2. Processing of Piping Materials**

When performing the refrigerant piping installation, care should be taken to ensure that water or dust does not enter the pipe interior, that no other oil than lubricating oils used in the installed air-water heat pump is used, and that refrigerant does not leak. When using lubricating oils in the piping processing, use such lubricating oils whose water content has been removed. When stored, be sure to seal the container with an airtight cap or any other cover.

**1. Flare processing procedures and precautions**

a) Cutting the Pipe

By means of a pipe cutter, slowly cut the pipe so that it is not deformed.

b) Removing Burrs and Chips

If the flared section has chips or burrs, refrigerant leakage may occur.

Carefully remove all burrs and clean the cut surface before installation.

c) Insertion of Flare Nut

d) Flare Processing

Make certain that a clamp bar and copper pipe have been cleaned.

By means of the clamp bar, perform the flare processing correctly.

Use either a flare tool for R410A/R32 or conventional flare tool.

Flare processing dimensions differ according to the type of flare tool. When using a conventional flare tool, be sure to secure “dimension A” by using a gauge for size adjustment.

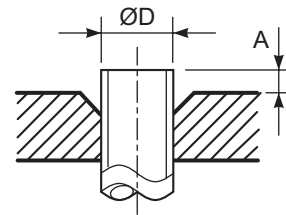


Fig. 3-2-1 Flare processing dimensions

Table 3-2-3 Dimensions related to flare processing for R410A or R32

Nominal diameter	Outer diameter (mm)	Thickness (mm)	A (mm)		
			Flare tool clutch type	Conventional flare tool	
				Clutch type	Wing nut type
1/4	6.35	0.8	0 to 0.5	1.0 to 1.5	1.5 to 2.0
3/8	9.52	0.8	0 to 0.5	1.0 to 1.5	1.5 to 2.0
1/2	12.70	0.8	0 to 0.5	1.0 to 1.5	2.0 to 2.5
5/8	15.88	1.0	0 to 0.5	1.0 to 1.5	2.0 to 2.5
3/4	19.05	1.2	0 to 0.5	1.0 to 1.5	2.0 to 2.5

Table 3-2-4 Dimensions related to flare processing for R22

Nominal diameter	Outer diameter (mm)	Thickness (mm)	A (mm)		
			Flare tool for R22 clutch type	Conventional flare tool	
				Clutch type	Wing nut type
1/4	6.35	0.8	0 to 0.5	0.5 to 1.0	1.0 to 1.5
3/8	9.52	0.8	0 to 0.5	0.5 to 1.0	1.0 to 1.5
1/2	12.70	0.8	0 to 0.5	0.5 to 1.0	1.5 to 2.0
5/8	15.88	1.0	0 to 0.5	0.5 to 1.0	1.5 to 2.0
3/4	19.05	1.2	0 to 0.5	-	-

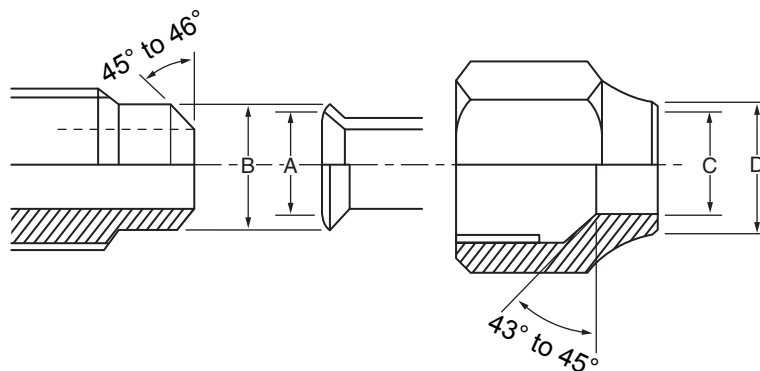
Table 3-2-5 Flare and flare nut dimensions for R410A or R32

Nominal diameter	Outer diameter (mm)	Thickness (mm)	Dimension (mm)				Flare nut width (mm)
			A	B	C	D	
1/4	6.35	0.8	9.1	9.2	6.5	13	17
3/8	9.52	0.8	13.2	13.5	9.7	20	22
1/2	12.70	0.8	16.0	16.6	12.9	23	26
5/8	15.88	1.0	19.0	19.7	16.0	25	29
3/4	19.05	1.2	24.0	-	19.2	28	36



**Table 3-2-6 Flare and flare nut dimensions for R22**

Nominal diameter	Outer diameter (mm)	Thickness (mm)	Dimension (mm)				Flare nut width (mm)
			A	B	C	D	
1/4	6.35	0.8	9.0	9.2	6.5	13	17
3/8	9.52	0.8	13.0	13.5	9.7	20	22
1/2	12.70	0.8	16.0	16.2	12.9	20	24
5/8	15.88	1.0	19.0	19.7	16.0	23	27
3/4	19.05	1.0	23.3	24.0	19.2	34	36



**Fig. 3-2-2 Relations between flare nut and flare seal surface**

## 2. Flare Connecting Procedures and Precautions

- Make sure that the flare and union portions do not have any scar or dust, etc.
- Correctly align the processed flare surface with the union axis.
- Tighten the flare with designated torque by means of a torque wrench. The tightening torque for R410A or R32 is the same as that for conventional R22. Incidentally, when the torque is weak, the gas leakage may occur. When it is strong, the flare nut may crack and may be made non-removable. When choosing the tightening torque, comply with values designated by manufacturers. Table 3-2-7 shows reference values.

### NOTE :

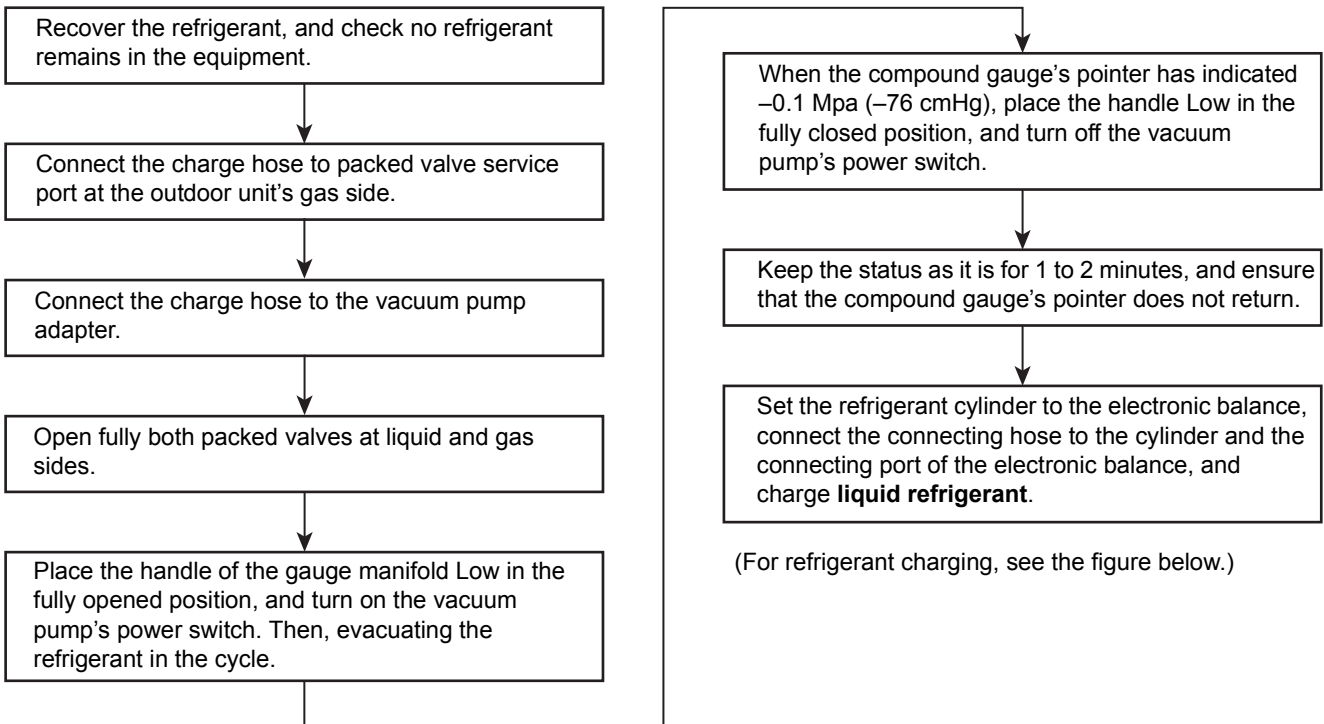
When applying oil to the flare surface, be sure to use oil designated by the manufacturer.  
If any other oil is used, the lubricating oils may deteriorate and cause the compressor to burn out.

**Table 3-2-7 Tightening torque of flare for R410A or R32 [Reference values]**

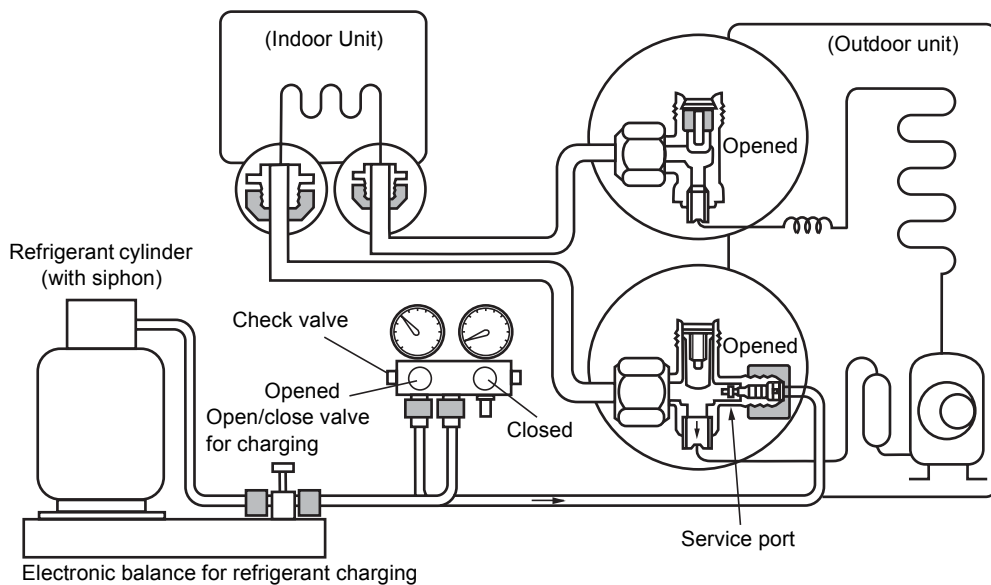
Nominal diameter	Outer diameter (mm)	Tightening torque N•m (kgf•cm)	Tightening torque of torque wrenches available on the market N•m (kgf•cm)
1/4	6.35	14 to 18 (140 to 180)	16 (160), 18 (180)
3/8	9.52	33 to 42 (330 to 420)	42 (420)
1/2	12.70	50 to 62 (500 to 620)	55 (550)
5/8	15.88	63 to 77 (630 to 770)	65 (650)
3/4	19.05	100 to 120 (10.0 to 12.0)	-

### 3-3. Recharging of Refrigerant

When it is necessary to recharge refrigerant, charge the specified amount of new refrigerant according to the following steps.



1. Never charge refrigerant exceeding the specified amount.
2. If the specified amount of refrigerant cannot be charged, charge refrigerant **bit by bit** in COOL mode.
3. Do not carry out additional charging.  
When additional charging is carried out if refrigerant leaks, the refrigerant composition changes in the refrigeration cycle, that is characteristics of the air conditioner changes, refrigerant exceeding the specified amount is charged, and working pressure in the refrigeration cycle becomes abnormally high pressure, and may cause a rupture or personal injury.



**Fig. 3-3-1 Configuration of refrigerant charging**

1. Be sure to make setting so that **liquid** can be charged.
2. When using a cylinder equipped with a siphon, liquid can be charged without turning it upside down.

#### R410A Model

It is necessary for charging refrigerant under condition of liquid because R410A is mixed type of refrigerant. Accordingly, when charging refrigerant from the refrigerant cylinder to the equipment, charge it turning the cylinder upside down if cylinder is not equipped with siphon.

#### R32 Model

R32 refrigerant is a Single-component refrigerant that does not change its composition.

Although it is possible to charge the refrigerant with either liquid or gas, charge it with liquid.

(If using gas for charging, composition of the refrigerant changes and then characteristics of the air conditioner change.)

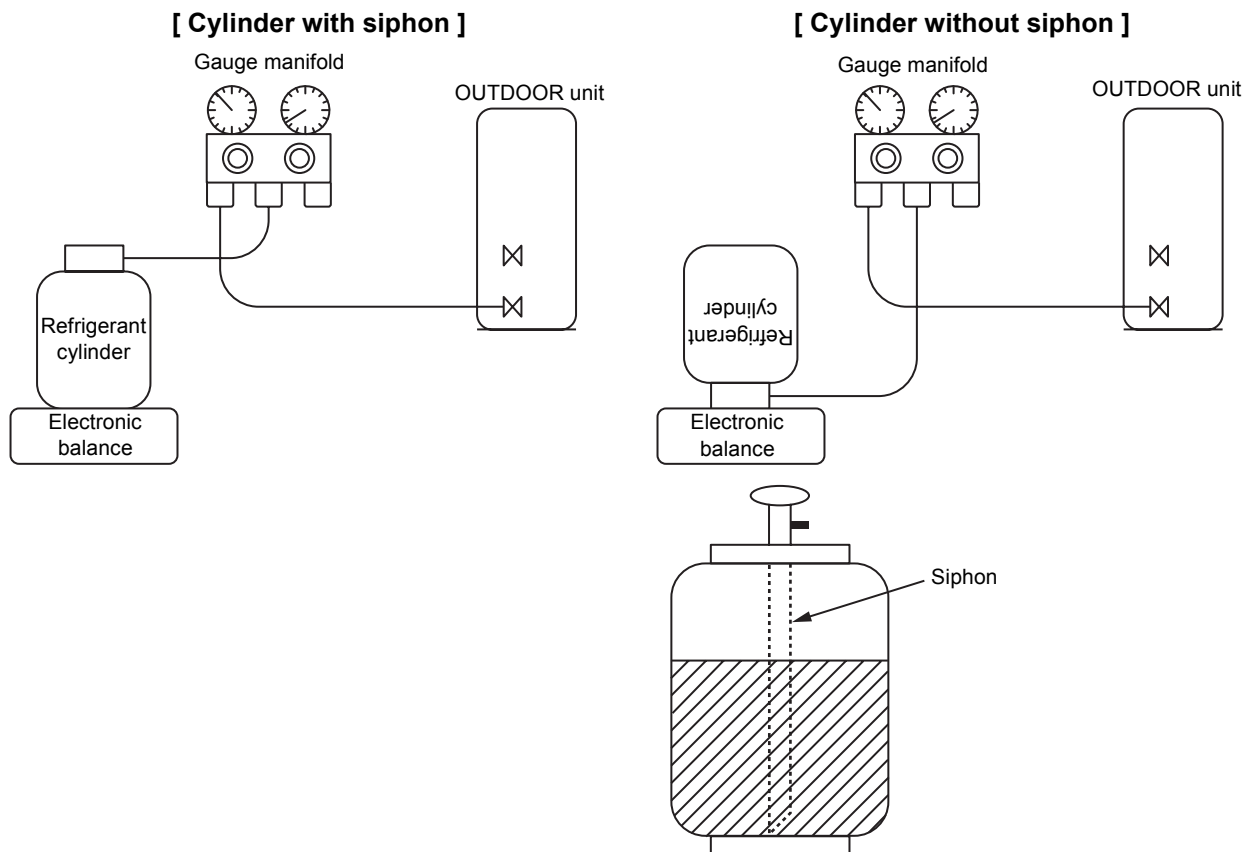


Fig. 3-3-2

### 3-4. Brazing of Pipes

#### 3-4-1. Materials for Brazing

##### 1. Silver brazing filler

Silver brazing filler is an alloy mainly composed of silver and copper. It is used to join iron, copper or copper alloy, and is relatively expensive though it excels in solderability.

##### 2. Phosphor bronze brazing filler

Phosphor bronze brazing filler is generally used to join copper or copper alloy.

##### 3. Low temperature brazing filler

Low temperature brazing filler is generally called solder, and is an alloy of tin and lead. Since it is weak in adhesive strength, do not use it for refrigerant pipes.

1. Phosphor bronze brazing filler tends to react with sulfur and produce a fragile compound water solution, which may cause a gas leakage. Therefore, use any other type of brazing filler at a hot spring resort, etc., and coat the surface with a paint.
2. When performing brazing again at time of servicing, use the same type of brazing filler.

#### 3-4-2. Flux

##### 1. Reason why flux is necessary

- By removing the oxide film and any foreign matter on the metal surface, it assists the flow of brazing filler.
- In the brazing process, it prevents the metal surface from being oxidized.

- By reducing the brazing filler's surface tension, the brazing filler adheres better to the treated metal.

## 2. Characteristics required for flux

- Activated temperature of flux coincides with the brazing temperature.
- Due to a wide effective temperature range, flux is hard to carbonize.
- It is easy to remove slag after brazing.
- The corrosive action to the treated metal and brazing filler is minimum.
- It excels in coating performance and is harmless to the human body.

As the flux works in a complicated manner as described above, it is necessary to select an adequate type of flux according to the type and shape of treated metal, type of brazing filler and brazing method, etc.

## 3. Types of flux

### • Noncorrosive flux

Generally, it is a compound of borax and boric acid. It is effective in case where the brazing temperature is higher than 800°C.

### • Activated flux

Most of fluxes generally used for silver brazing are this type.

It features an increased oxide film removing capability due to the addition of compounds such as potassium fluoride, potassium chloride and sodium fluoride to the borax-boric acid compound.

## 4. Piping materials for brazing and used brazing filler/flux

Piping material	Used brazing filler	Used flux
Copper - Copper	Phosphor copper	Do not use
Copper - Iron	Silver	Paste flux
Iron - Iron	Silver	Vapor flux

1. Do not enter flux into the refrigeration cycle.
2. When chlorine contained in the flux remains within the pipe, the lubricating oil deteriorates. Therefore, use a flux which does not contain chlorine.
3. When adding water to the flux, use water which does not contain chlorine (e.g. distilled water or ion-exchange water).
4. Remove the flux after brazing.

## 3-4-3. Brazing

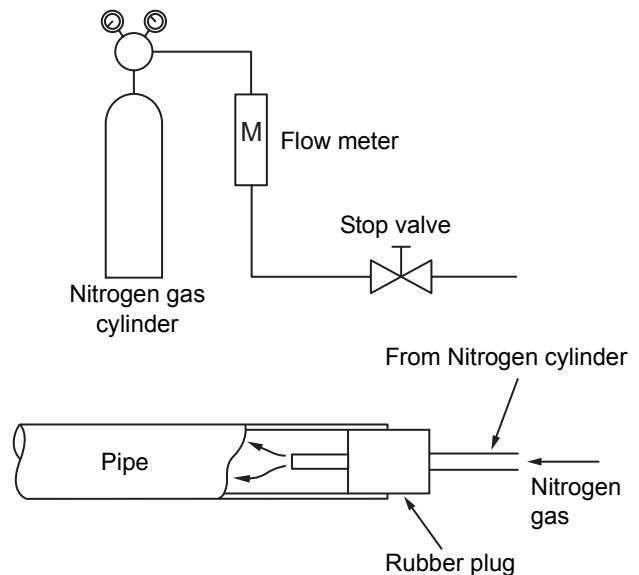
As brazing work requires sophisticated techniques, experiences based upon a theoretical knowledge, it must be performed by a person qualified.

In order to prevent the oxide film from occurring in the pipe interior during brazing, it is effective to proceed with brazing while letting dry Nitrogen gas (N<sub>2</sub>) flow.

**Never use gas other than Nitrogen gas.**

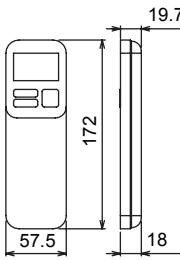
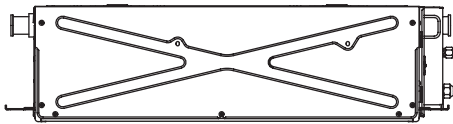
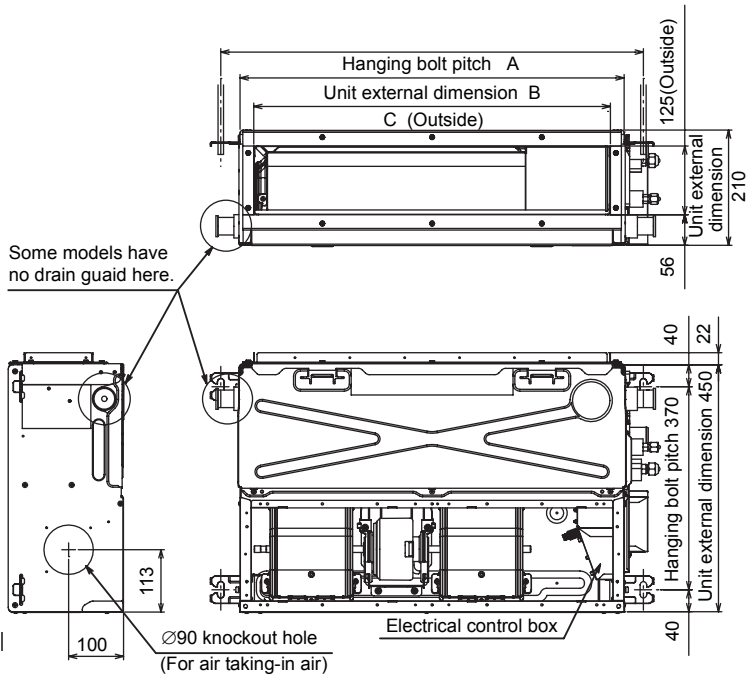
### 1. Brazing method to prevent oxidation

- 1) Attach a reducing valve and a flow-meter to the Nitrogen gas cylinder.
- 2) Use a copper pipe to direct the piping material, and attach a flow-meter to the cylinder.
- 3) Apply a seal onto the clearance between the piping material and inserted copper pipe for Nitrogen in order to prevent backflow of the Nitrogen gas.
- 4) When the Nitrogen gas is flowing, be sure to keep the piping end open.
- 5) Adjust the flow rate of Nitrogen gas so that it is lower than 0.05 m<sup>3</sup>/Hr or 0.02 MPa (0.2kgf/cm<sup>2</sup>) by means of the reducing valve.
- 6) After performing the steps above, keep the Nitrogen gas flowing until the pipe cools down to a certain extent (temperature at which pipes are touchable with hands).
- 7) Remove the flux completely after brazing.

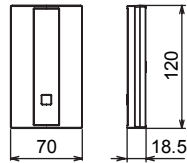


**Fig. 3-4-1 Prevention of oxidation during brazing**

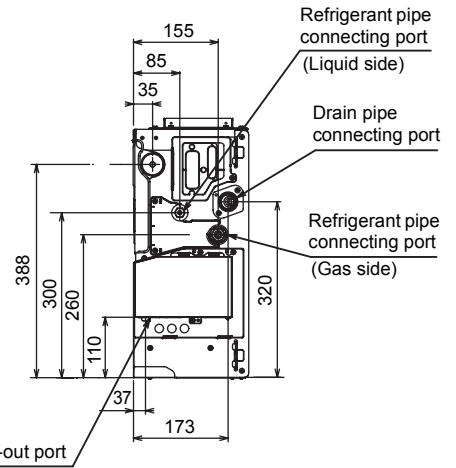
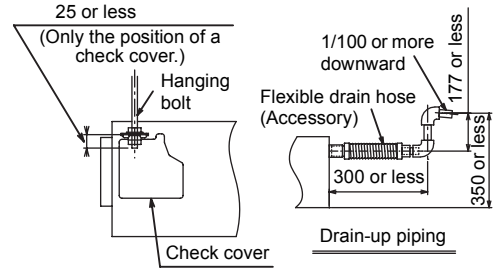
# 4. CONSTRUCTION VIEWS



WIRELESS REMOTE CONTROLLER

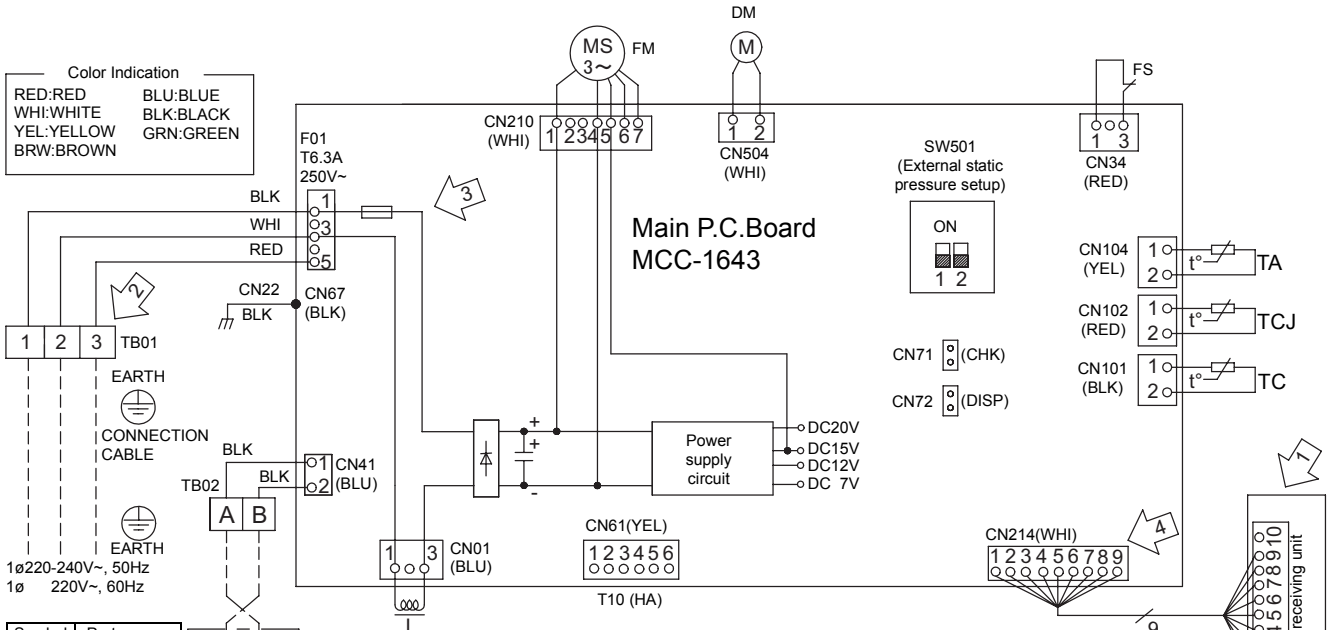


SIGNAL RECEIVING UNIT



	A	B	C
07,13 type	770	700	650
16 type	970	900	850
22,24 type	1,170	1,100	1,050

# 5. WIRING DIAGRAM



Symbol	Parts name
CN**	Connector
F01	Fuse
FM	Fan Motor
TA	Indoor temp. sensor
TB01,02	Terminal Block
TC,TCJ	Temp. sensor
DM	Drain pump Motor
FS	Float Switch
L	Reactor

- Broken line indicate the wiring at site. Long dashed short dashed line indicate the accessories.
- indicates the terminal block.
  - indicates the connection terminal.
  - indicates the connector on the control P.C. board.
- ⊕ indicates the protection ground.
- indicates the control P.C. board.

**Quick check for diagnosing faults**

Check Items	Diagnosis result
↑1 OPERATION indicator	Check to see if the OPERATION indicator goes on & off when the main switch or circuit breakers turned on, or power cord is plugged in the wall outlet.
↑2 Terminal block	Check for the voltage between ① and ② is 220 to 240VAC. Check for the voltage between ③ and ④ is 15 to 60VDC.
↑3 Fuse 6.3A	Check Varistor if the fuse is open.
↑4 DC5V	Check for the voltage between ⑤ and ⑥ terminal of CN214.

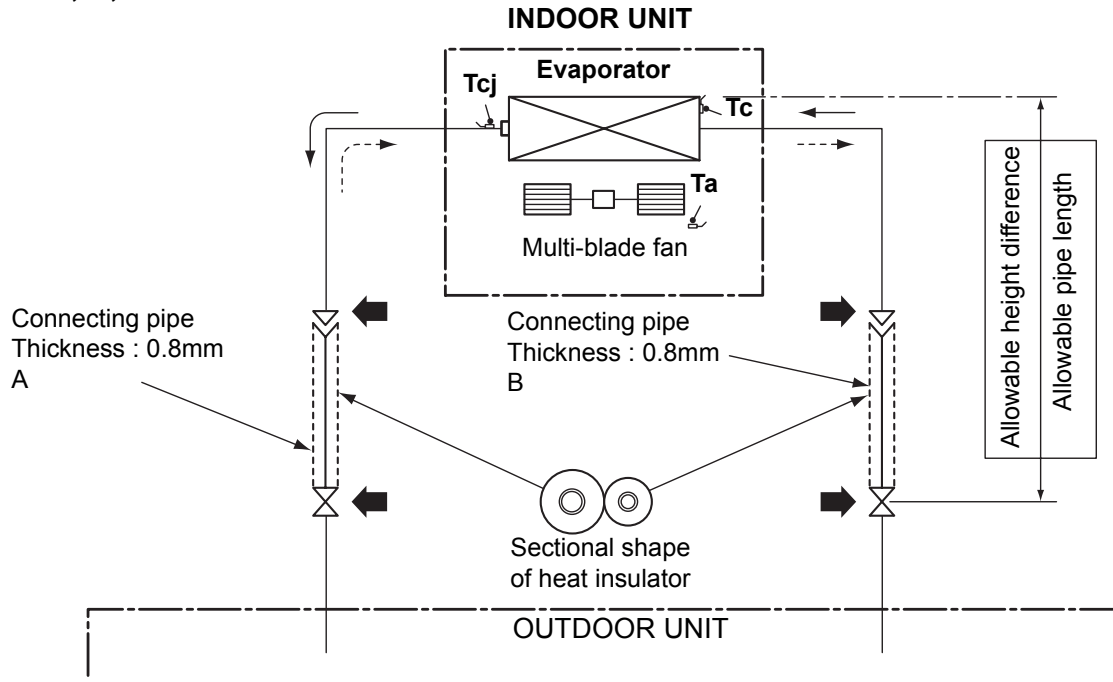
## 6. SPECIFICATIONS OF ELECTRICAL PARTS

Model	RAS-M***G3DV*	07	10	13	16
Fan motor	RAS-M**G3DV-E/TR	ICF-340WD50-1 or ICF-340WD94-3 or WDF-340WD50-1			ICF-340WD94-3 or WDF-340WD94-1
	RAS-M**G3DV-ND	ICF-340WD94-4			
Drain pump motor		MDP-1401			
Float switch		FS-1A-31			
P.C. board		MCC-1643			
TA sensor		Lead wire length : 328mm Vinyl tube			
TC sensor		Ø6 size lead wire length : 1000mm Vinyl tube (Black)			
TCJ sensor		Ø6 size lead wire length : 1000mm Vinyl tube (Red)			

Model	RAS-M**U2DVG*	07	10	13	16	22	24
Fan motor		ICF-340WD50-1 or ICF-340WD94-3 or WDF-340WD50-1			ICF-340WD94-3 or WDF-340WD94-1		
Drain pump motor		MDP-1401					
Float switch		FS-1A-31					
P.C. board		MCC-1643					
TA sensor		Lead wire length : 328mm Vinyl tube					
TC sensor		Ø6 size lead wire length : 1000mm Vinyl tube (Black)					
TCJ sensor		Ø6 size lead wire length : 1000mm Vinyl tube (Red)					

## 7. REFRIGERANT CYCLE DIAGRAM

RAS-M07,10,13G3DV



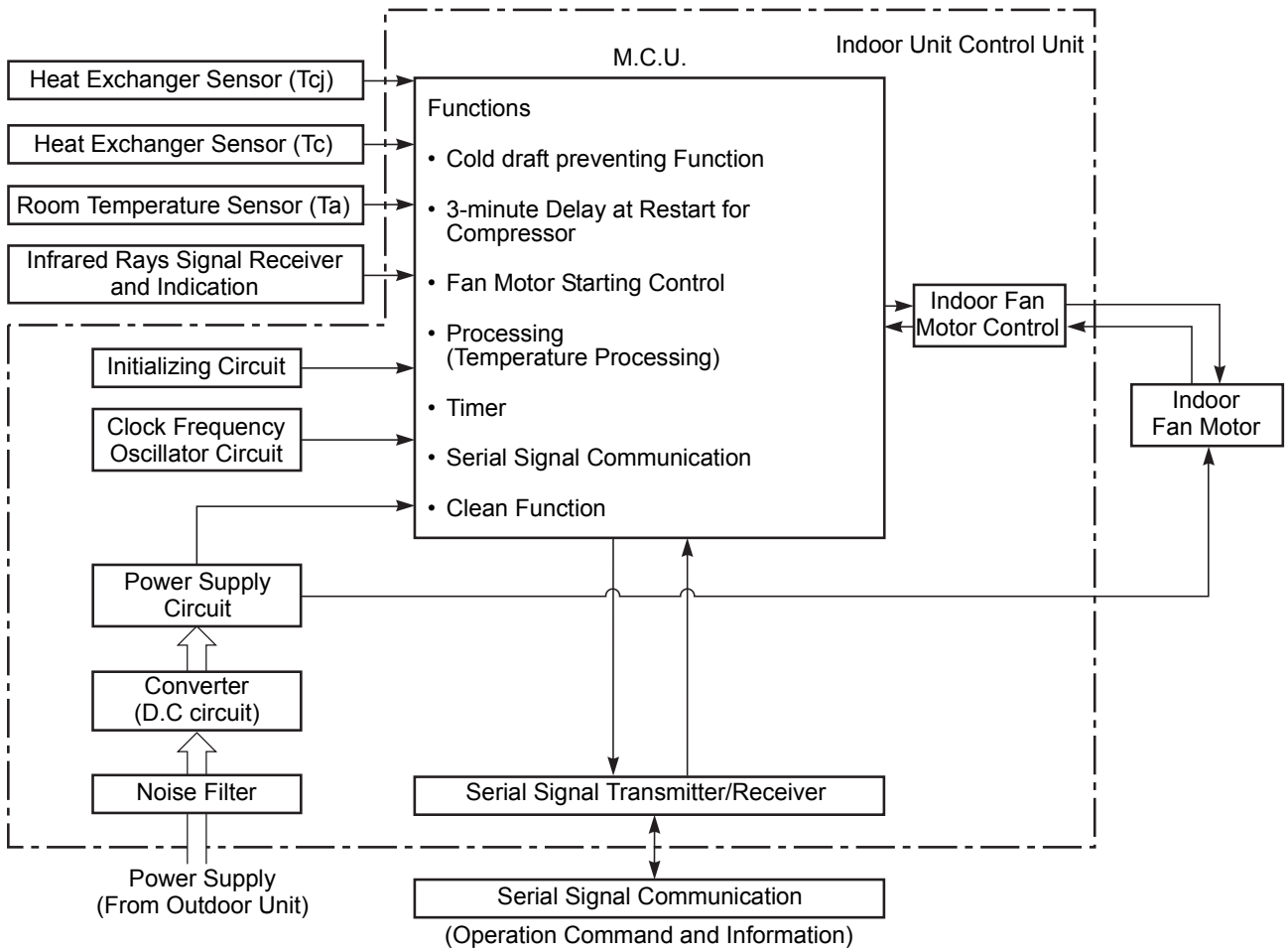
Type	A	B
07,10,13	Ø9.52	Ø6.35
16	Ø12.70	Ø6.35
22,24	Ø12.70	Ø6.35

**NOTE :** Gas leak check position  
 Refrigerant flow (Cooling)  
 Refrigerant flow (Heating)

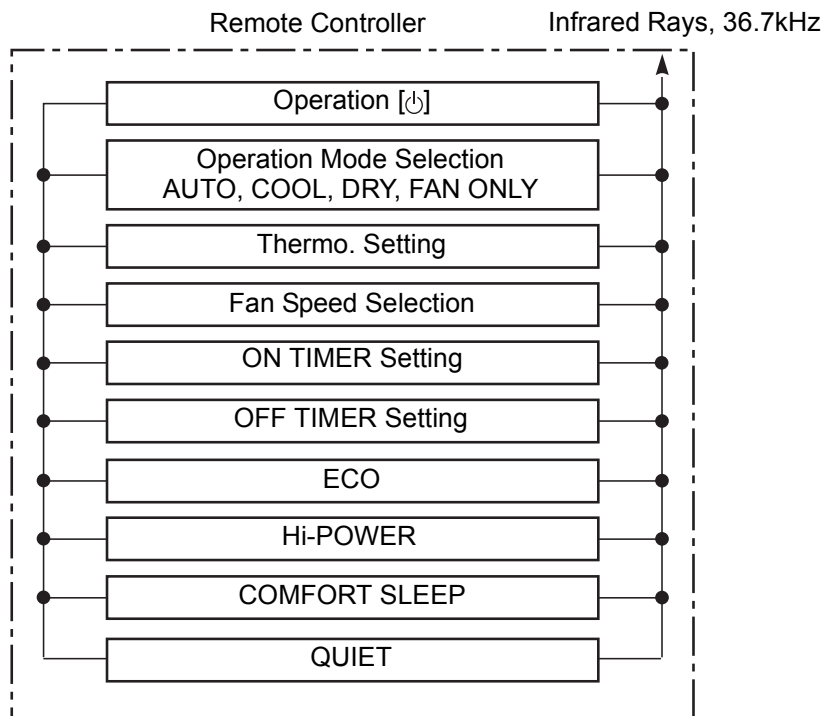
- The allowable pipe length, charge amount of refrigerant, and allowable height difference differ according to the outdoor unit to be combined.  
 For details, refer to the service manual of the outdoor unit to be combined.



## 8. CONTROL BLOCK DIAGRAM



### REMOTE CONTROLLER



## 9. OPERATION DESCRIPTION

<b>9-1. Outline of Air Conditioner Control.....</b>	<b>30</b>
<b>9-2. Operation Description.....</b>	<b>31</b>
1. Basic operation .....	31
1-1. Operation control .....	31
1-2. When power supply is reset.....	32
1-3. Operating mode selection when performing 2-room operation.....	32
1-4. Cooling/Heating operation .....	33
1-5. AUTO operation.....	34
1-6. DRY operation .....	34
2. Indoor fan motor control .....	35
3. Capacity control .....	38
4. Release protective control by temperature of indoor heat exchanger.....	39
5. Drain pump control.....	40
6. After-heat elimination .....	40
7. Intermittent Operation Control for Indoor Fans of the Indoor Unit at Thermo-off Side in Heating Operation .....	41
8. Additional Operation.....	42
8-1. QUIET mode.....	42
8-2. Hi-POWER Mode.....	42
8-3. ECO mode .....	42
8-4. COMFORT SLEEP mode .....	43
9. One-Touch Comfort .....	43
10. Temporary operation.....	43
11. Frequency fixed operation (Test run) .....	44
12. Self-Cleaning function .....	45
13. Self-Cleaning function release .....	46
14. Suction temperature correction .....	46
15. Remote-A or B selection .....	47
16. Short Timer .....	47
17. External static pressure settings .....	48
<b>9-3. Auto Restart Function.....</b>	<b>49</b>
9-3-1. How to Set the Auto Restart Function .....	49
9-3-2. How to Cancel the Auto Restart Function.....	50
9-3-3. Power Failure During Timer Operation .....	50
<b>9-4. Remote control.....</b>	<b>51</b>
9-4-1. Remote control and its functions .....	51
9-4-2. Operation of remote control .....	51
9-4-3. Name and Functions of Indications on Remote Controller .....	54

## 9-1. Outline of Air Conditioner Control

This air conditioner is a capacity-variable type air conditioner, which uses DC motor for the indoor fan motor and the outdoor fan motor. And the capacityproportional control compressor mounted. The DC motor drive circuit is mounted to the indoor unit. The compressor and the inverter to control fan motor are mounted to the outdoor unit.

The entire air conditioner is mainly controlled by the indoor unit controller.

The indoor unit controller drives the indoor fan motor based upon command sent from the remote controller, and transfers the operation command to the outdoor unit controller.

The outdoor unit controller receives operation command from the indoor unit side, and controls the outdoor fan and the pulse motor valve. (P.M.V) Besides, detecting revolution position of the compressor motor, the outdoor unit controller controls speed of the compressor motor by controlling output voltage of the inverter and switching timing of the supply power (current transfer timing) so that motors drive according to the operation command.

And then, the outdoor unit controller transfers reversely the operating status information of the outdoor unit to control the indoor unit controller.

**As the compressor adopts four-pole brushless DC motor, the frequency of the supply power from inverter to compressor is two-times cycles of the actual number of revolution.**

### 1. Role of indoor unit controller

The indoor unit controller judges the operation commands from the remote controller and assumes the following functions.

- Judgment of suction air temperature of the indoor heat exchanger by using the indoor temp. sensor. (TA sensor)
- Judgment of the indoor heat exchanger temperature by using heat exchanger sensor (TC sensor) (Prevent-freezing control, etc.)
- Indoor fan motor operation control
- LED (Light Emitting Diode) display control
- Transferring of operation command signal (Serial signal) to the outdoor unit
- Reception of information of operation status (Serial signal including outside temp. data) to the outdoor unit and judgment/display of error

### 2. Role of outdoor unit controller

Receiving the operation command signal (Serial signal) from the indoor unit controller, the outdoor unit performs its role.

- Compressor operation control
- Operation control of outdoor fan motor
- P.M.V. control
- 4-way valve control

} Operations followed to judgment of serial signal from indoor side.

- Detection of inverter input current and current release operation
- Over-current detection and prevention operation to IGBT module (Compressor stop function)
- Compressor and outdoor fan stop function when serial signal is off (when the serial signal does not reach the board assembly of outdoor control by trouble of the signal system)
- Transferring of operation information (Serial signal) from outdoor unit controller to indoor unit controller
- Detection of outdoor temperature and operation revolution control
- Defrost control in heating operation (Temp. measurement by outdoor heat exchanger and control for 4-way valve and outdoor fan)

### 3. Contents of operation command signal (Serial signal) from indoor unit controller to outdoor unit controller

The following three types of signals are sent from the indoor unit controller.

- Operation mode set on the remote controller
- Compressor revolution command signal defined by indoor temperature and set temperature (Correction along with variation of room temperature and correction of indoor heat exchanger temperature are added.)
- Temperature of indoor heat exchanger
- For these signals ([Operation mode] and [Compressor revolution] indoor heat exchanger temperature), the outdoor unit controller monitors the input current to the inverter, and performs the followed operation within the range that current does not exceed the allowable value.

### 4. Contents of operation command signal (Serial signal) from outdoor unit controller to indoor unit controller

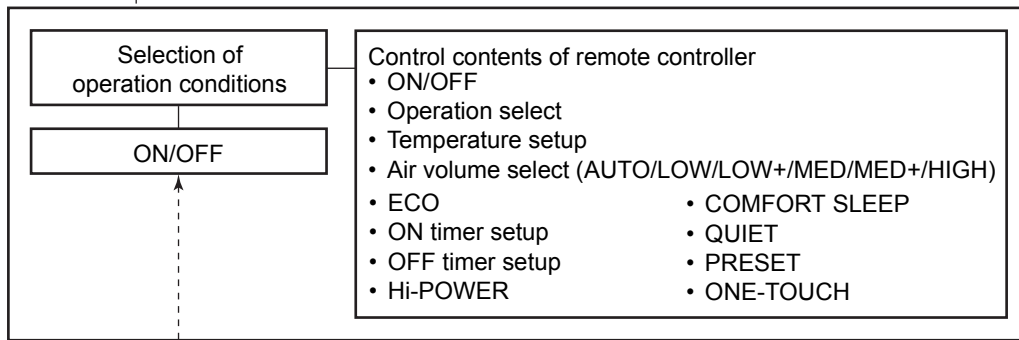
The following signals are sent from the outdoor unit controller.

- The current operation mode
- The current compressor revolution
- Outdoor temperature
- Existence of protective circuit operation For transferring of these signals, the indoor unit controller monitors the contents of signals, and judges existence of trouble occurrence. Contents of judgment are described below.
  - Whether distinction of the current operation status meets to the operation command signal
  - Whether protective circuit operates When no signal is received from the outdoor unit controller, it is assumed as a trouble.

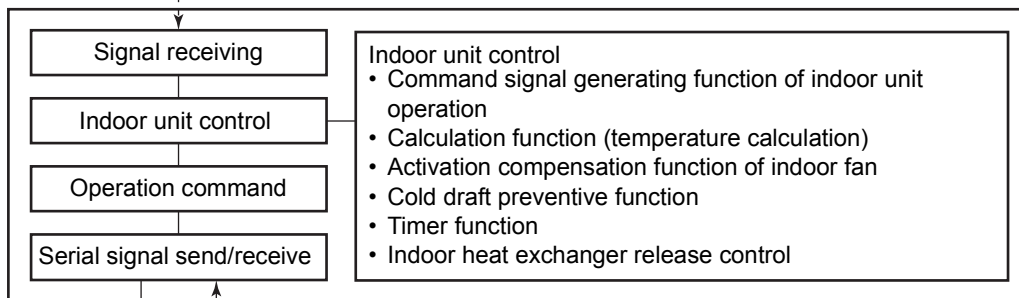
## 9-2. Operation Description

Item	Operation flow and applicable data, etc.	Description
<p><b>1. Basic operation</b></p>	<p><b>1-1. Operation control</b></p> <p>Receiving the user's operation condition setup, the operation statuses of indoor/outdoor units are controlled.</p> <ol style="list-style-type: none"> <li>1) The operation conditions are selected by the remote controller as shown in the below.</li> <li>2) A signal is sent by ON button of the remote controller.</li> <li>3) The signal is received by a sensor of the indoor unit and processed by the indoor controllers as shown in the below.</li> <li>4) The indoor controller controls the indoor fan motor and louver motor.</li> <li>5) The indoor controller sends the operation command to the outdoor controller, and sends/receives the control status with a serial signal.</li> <li>6) The outdoor controller controls the operation as shown in the left, and also controls the compressor, outdoor fan motor, 4-way valve and pulse motor valve.</li> </ol>	

### Remote controller

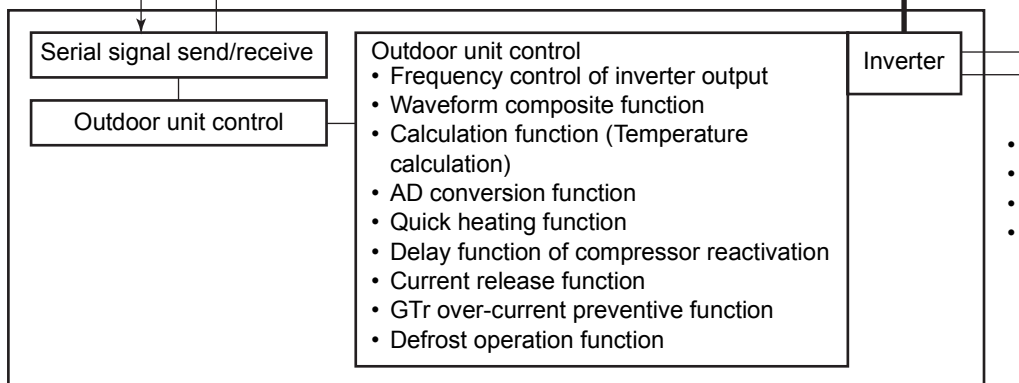


### Indoor unit



- Indoor fan motor
- drain pump

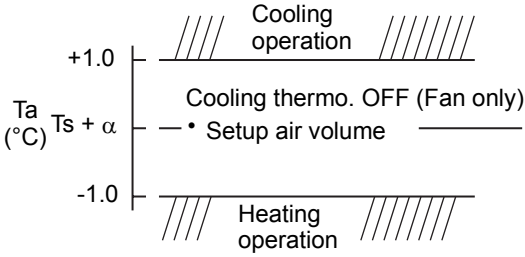
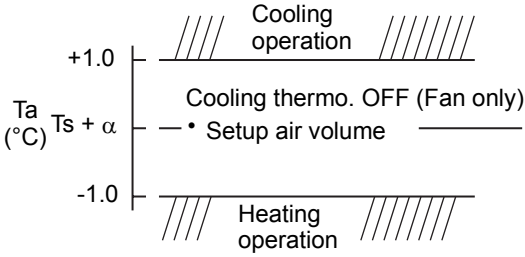
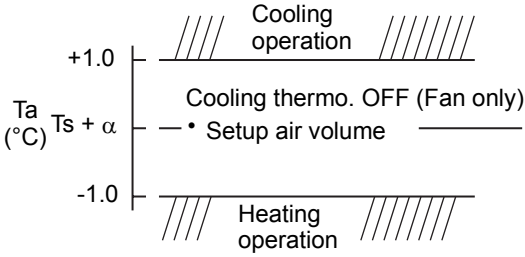
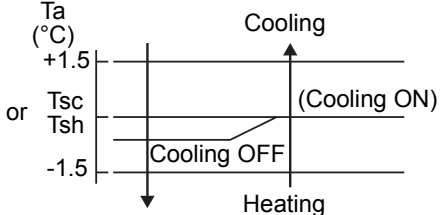
### Outdoor unit



- Compressor
- Outdoor fan motor
- 4-way valve
- Pulse motorvalve (P.M.V.)

Item	Operation flow and applicable data, etc.	Description																																																																																																																			
1. Basic operation	<b>1-2. When power supply is reset</b> 1) Based on EEPROM data and DIPSW, setting of the indoor fan speed and other setting are loaded. During this loading (approx 30 seconds), operation cannot be accepted.	Air speed (rpm)																																																																																																																			
	<b>1-3. Operating mode selection when performing 2-room operation</b> 1) The outdoor unit operation mode conforms to the instructions of the indoor unit that was pressed first. 2) When combined operation consisting of cooling (dry) and heating, fan and heating, or cleaning operation and heating is performed, operation conforms to the instructions of the indoor unit that was pressed first as shown in the following table. 3) The indoor fan stops for the indoor unit that was pressed last and which instructions are ignored. 4) When three or four indoor units are operated concurrently, the priority is also given to operating mode of the indoor unit which was pressed first as same as the case when two indoor units are operated concurrently. <table border="1" data-bbox="336 719 1444 1646"> <thead> <tr> <th data-bbox="336 719 392 745">No.</th> <th data-bbox="392 719 552 745">Indoor unit</th> <th data-bbox="552 719 794 745">Set operating mode</th> <th data-bbox="794 719 1115 745">Actual indoor unit operation</th> <th data-bbox="1115 719 1444 745">Actual outdoor unit operation</th> </tr> </thead> <tbody> <tr> <td data-bbox="336 745 392 815" rowspan="2">1</td> <td data-bbox="392 745 552 772">Pressed first</td> <td data-bbox="552 745 794 772">Cooling (dry)</td> <td data-bbox="794 745 1115 772">Cooling (dry)</td> <td data-bbox="1115 745 1444 815" rowspan="2">Cooling</td> </tr> <tr> <td data-bbox="392 772 552 815">Pressed last</td> <td data-bbox="552 772 794 815">Cooling (dry)</td> <td data-bbox="794 772 1115 815">Cooling (dry)</td> </tr> <tr> <td data-bbox="336 815 392 875" rowspan="2">2</td> <td data-bbox="392 815 552 842">Pressed first</td> <td data-bbox="552 815 794 842">Heating</td> <td data-bbox="794 815 1115 842">Heating</td> <td data-bbox="1115 815 1444 875" rowspan="2">Heating</td> </tr> <tr> <td data-bbox="392 842 552 875">Pressed last</td> <td data-bbox="552 842 794 875">Heating</td> <td data-bbox="794 842 1115 875">Heating</td> </tr> <tr> <td data-bbox="336 875 392 943" rowspan="2">3</td> <td data-bbox="392 875 552 902">Pressed first</td> <td data-bbox="552 875 794 902">Fan only</td> <td data-bbox="794 875 1115 902">Fan only</td> <td data-bbox="1115 875 1444 943" rowspan="2">Stopped</td> </tr> <tr> <td data-bbox="392 902 552 943">Pressed last</td> <td data-bbox="552 902 794 943">Fan only</td> <td data-bbox="794 902 1115 943">Fan only</td> </tr> <tr> <td data-bbox="336 943 392 1003" rowspan="2">4</td> <td data-bbox="392 943 552 969">Pressed first</td> <td data-bbox="552 943 794 969">Fan only</td> <td data-bbox="794 943 1115 969">Fan only</td> <td data-bbox="1115 943 1444 1003" rowspan="2">Cooling</td> </tr> <tr> <td data-bbox="392 969 552 1003">Pressed last</td> <td data-bbox="552 969 794 1003">Cooling (dry)</td> <td data-bbox="794 969 1115 1003">Cooling (dry)</td> </tr> <tr> <td data-bbox="336 1003 392 1070" rowspan="2">5</td> <td data-bbox="392 1003 552 1030">Pressed first</td> <td data-bbox="552 1003 794 1030">Cooling (dry)</td> <td data-bbox="794 1003 1115 1030">Cooling (dry)</td> <td data-bbox="1115 1003 1444 1070" rowspan="2">Cooling</td> </tr> <tr> <td data-bbox="392 1030 552 1070">Pressed last</td> <td data-bbox="552 1030 794 1070">Fan only</td> <td data-bbox="794 1030 1115 1070">Fan only</td> </tr> <tr> <td data-bbox="336 1070 392 1131" rowspan="2">6</td> <td data-bbox="392 1070 552 1097">Pressed first</td> <td data-bbox="552 1070 794 1097">Cooling (dry)</td> <td data-bbox="794 1070 1115 1097">Cooling (dry)</td> <td data-bbox="1115 1070 1444 1131" rowspan="2">Cooling</td> </tr> <tr> <td data-bbox="392 1097 552 1131">Pressed last</td> <td data-bbox="552 1097 794 1131">Heating</td> <td data-bbox="794 1097 1115 1131">Fan stopped</td> </tr> <tr> <td data-bbox="336 1131 392 1198" rowspan="2">7</td> <td data-bbox="392 1131 552 1158">Pressed first</td> <td data-bbox="552 1131 794 1158">Heating</td> <td data-bbox="794 1131 1115 1158">Heating</td> <td data-bbox="1115 1131 1444 1198" rowspan="2">Heating</td> </tr> <tr> <td data-bbox="392 1158 552 1198">Pressed last</td> <td data-bbox="552 1158 794 1198">Cooling (dry)</td> <td data-bbox="794 1158 1115 1198">Fan stopped</td> </tr> <tr> <td data-bbox="336 1198 392 1258" rowspan="2">8</td> <td data-bbox="392 1198 552 1225">Pressed first</td> <td data-bbox="552 1198 794 1225">Cleaning operation</td> <td data-bbox="794 1198 1115 1225">Cleaning operation</td> <td data-bbox="1115 1198 1444 1258" rowspan="2">Stopped</td> </tr> <tr> <td data-bbox="392 1225 552 1258">Pressed last</td> <td data-bbox="552 1225 794 1258">Cleaning operation</td> <td data-bbox="794 1225 1115 1258">Cleaning operation</td> </tr> <tr> <td data-bbox="336 1258 392 1326" rowspan="2">9</td> <td data-bbox="392 1258 552 1285">Pressed first</td> <td data-bbox="552 1258 794 1285">Cleaning operation</td> <td data-bbox="794 1258 1115 1285">Cleaning operation</td> <td data-bbox="1115 1258 1444 1326" rowspan="2">Cooling</td> </tr> <tr> <td data-bbox="392 1285 552 1326">Pressed last</td> <td data-bbox="552 1285 794 1326">Cooling (dry)</td> <td data-bbox="794 1285 1115 1326">Cooling (dry)</td> </tr> <tr> <td data-bbox="336 1326 392 1393" rowspan="2">10</td> <td data-bbox="392 1326 552 1352">Pressed first</td> <td data-bbox="552 1326 794 1352">Cooling (dry)</td> <td data-bbox="794 1326 1115 1352">Cooling (dry)</td> <td data-bbox="1115 1326 1444 1393" rowspan="2">Cooling</td> </tr> <tr> <td data-bbox="392 1352 552 1393">Pressed last</td> <td data-bbox="552 1352 794 1393">Cleaning operation</td> <td data-bbox="794 1352 1115 1393">Cleaning operation</td> </tr> <tr> <td data-bbox="336 1393 392 1460" rowspan="2">11</td> <td data-bbox="392 1393 552 1420">Pressed first</td> <td data-bbox="552 1393 794 1420">Cleaning operation</td> <td data-bbox="794 1393 1115 1420">Cleaning operation</td> <td data-bbox="1115 1393 1444 1460" rowspan="2">Stopped</td> </tr> <tr> <td data-bbox="392 1420 552 1460">Pressed last</td> <td data-bbox="552 1420 794 1460">Fan only</td> <td data-bbox="794 1420 1115 1460">Fan only</td> </tr> <tr> <td data-bbox="336 1460 392 1527" rowspan="2">12</td> <td data-bbox="392 1460 552 1487">Pressed first</td> <td data-bbox="552 1460 794 1487">Fan only</td> <td data-bbox="794 1460 1115 1487">Fan only</td> <td data-bbox="1115 1460 1444 1527" rowspan="2">Stopped</td> </tr> <tr> <td data-bbox="392 1487 552 1527">Pressed last</td> <td data-bbox="552 1487 794 1527">Cleaning operation</td> <td data-bbox="794 1487 1115 1527">Cleaning operation</td> </tr> <tr> <td data-bbox="336 1527 392 1594" rowspan="2">13</td> <td data-bbox="392 1527 552 1554">Pressed first</td> <td data-bbox="552 1527 794 1554">Cleaning operation</td> <td data-bbox="794 1527 1115 1554">Cleaning operation</td> <td data-bbox="1115 1527 1444 1594" rowspan="2">Stopped</td> </tr> <tr> <td data-bbox="392 1554 552 1594">Pressed last</td> <td data-bbox="552 1554 794 1594">Heating</td> <td data-bbox="794 1554 1115 1594">Fan stopped</td> </tr> <tr> <td data-bbox="336 1594 392 1646" rowspan="2">14</td> <td data-bbox="392 1594 552 1621">Pressed first</td> <td data-bbox="552 1594 794 1621">Heating</td> <td data-bbox="794 1594 1115 1621">Heating</td> <td data-bbox="1115 1594 1444 1646" rowspan="2">Heating</td> </tr> <tr> <td data-bbox="392 1621 552 1646">Pressed last</td> <td data-bbox="552 1621 794 1646">Cleaning operation</td> <td data-bbox="794 1621 1115 1646">Fan stopped</td> </tr> </tbody> </table>	No.	Indoor unit	Set operating mode	Actual indoor unit operation	Actual outdoor unit operation	1	Pressed first	Cooling (dry)	Cooling (dry)	Cooling	Pressed last	Cooling (dry)	Cooling (dry)	2	Pressed first	Heating	Heating	Heating	Pressed last	Heating	Heating	3	Pressed first	Fan only	Fan only	Stopped	Pressed last	Fan only	Fan only	4	Pressed first	Fan only	Fan only	Cooling	Pressed last	Cooling (dry)	Cooling (dry)	5	Pressed first	Cooling (dry)	Cooling (dry)	Cooling	Pressed last	Fan only	Fan only	6	Pressed first	Cooling (dry)	Cooling (dry)	Cooling	Pressed last	Heating	Fan stopped	7	Pressed first	Heating	Heating	Heating	Pressed last	Cooling (dry)	Fan stopped	8	Pressed first	Cleaning operation	Cleaning operation	Stopped	Pressed last	Cleaning operation	Cleaning operation	9	Pressed first	Cleaning operation	Cleaning operation	Cooling	Pressed last	Cooling (dry)	Cooling (dry)	10	Pressed first	Cooling (dry)	Cooling (dry)	Cooling	Pressed last	Cleaning operation	Cleaning operation	11	Pressed first	Cleaning operation	Cleaning operation	Stopped	Pressed last	Fan only	Fan only	12	Pressed first	Fan only	Fan only	Stopped	Pressed last	Cleaning operation	Cleaning operation	13	Pressed first	Cleaning operation	Cleaning operation	Stopped	Pressed last	Heating	Fan stopped	14	Pressed first	Heating	Heating	Heating	Pressed last	Cleaning operation
No.	Indoor unit	Set operating mode	Actual indoor unit operation	Actual outdoor unit operation																																																																																																																	
1	Pressed first	Cooling (dry)	Cooling (dry)	Cooling																																																																																																																	
	Pressed last	Cooling (dry)	Cooling (dry)																																																																																																																		
2	Pressed first	Heating	Heating	Heating																																																																																																																	
	Pressed last	Heating	Heating																																																																																																																		
3	Pressed first	Fan only	Fan only	Stopped																																																																																																																	
	Pressed last	Fan only	Fan only																																																																																																																		
4	Pressed first	Fan only	Fan only	Cooling																																																																																																																	
	Pressed last	Cooling (dry)	Cooling (dry)																																																																																																																		
5	Pressed first	Cooling (dry)	Cooling (dry)	Cooling																																																																																																																	
	Pressed last	Fan only	Fan only																																																																																																																		
6	Pressed first	Cooling (dry)	Cooling (dry)	Cooling																																																																																																																	
	Pressed last	Heating	Fan stopped																																																																																																																		
7	Pressed first	Heating	Heating	Heating																																																																																																																	
	Pressed last	Cooling (dry)	Fan stopped																																																																																																																		
8	Pressed first	Cleaning operation	Cleaning operation	Stopped																																																																																																																	
	Pressed last	Cleaning operation	Cleaning operation																																																																																																																		
9	Pressed first	Cleaning operation	Cleaning operation	Cooling																																																																																																																	
	Pressed last	Cooling (dry)	Cooling (dry)																																																																																																																		
10	Pressed first	Cooling (dry)	Cooling (dry)	Cooling																																																																																																																	
	Pressed last	Cleaning operation	Cleaning operation																																																																																																																		
11	Pressed first	Cleaning operation	Cleaning operation	Stopped																																																																																																																	
	Pressed last	Fan only	Fan only																																																																																																																		
12	Pressed first	Fan only	Fan only	Stopped																																																																																																																	
	Pressed last	Cleaning operation	Cleaning operation																																																																																																																		
13	Pressed first	Cleaning operation	Cleaning operation	Stopped																																																																																																																	
	Pressed last	Heating	Fan stopped																																																																																																																		
14	Pressed first	Heating	Heating	Heating																																																																																																																	
	Pressed last	Cleaning operation	Fan stopped																																																																																																																		


Item	Operation flow and applicable data, etc.	Description
<b>1. Basic operation</b>	<p><b>1-4. Cooling/Heating operation</b></p> <p>The operations are performed in the following parts by controls according to cooling/heating conditions.</p> <ol style="list-style-type: none"> <li>1) Receiving the operation ON signal of the remote controller, the cooling or heating operation signal starts being transferred from the indoor controller to the outdoor unit.</li> <li>2) At the indoor unit side, the indoor fan is operated according to the contents of “<b>2. Indoor fan motor control</b>” and the drain pump according to the “<b>5. Drain pump control</b>”.</li> <li>3) The outdoor unit controls the outdoor fan motor, compressor, pulse motor valve and 4-way valve according to the operation signal sent from the indoor unit.</li> </ol> <pre> graph TD     A[Operation On] --&gt; B[Indoor unit control]     C[Setup of remote controller] --- A     B --- D[Indoor fan motor control / drain pump]     B --&gt; E[Sending of operation command signal]     E --&gt; F[Outdoor unit control]     F -.-&gt; B     F --- G[Compressor revolution control / Outdoor fan motor control / 4-way valve control Pulse motor valve control]   </pre>	

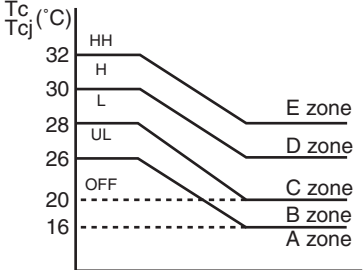
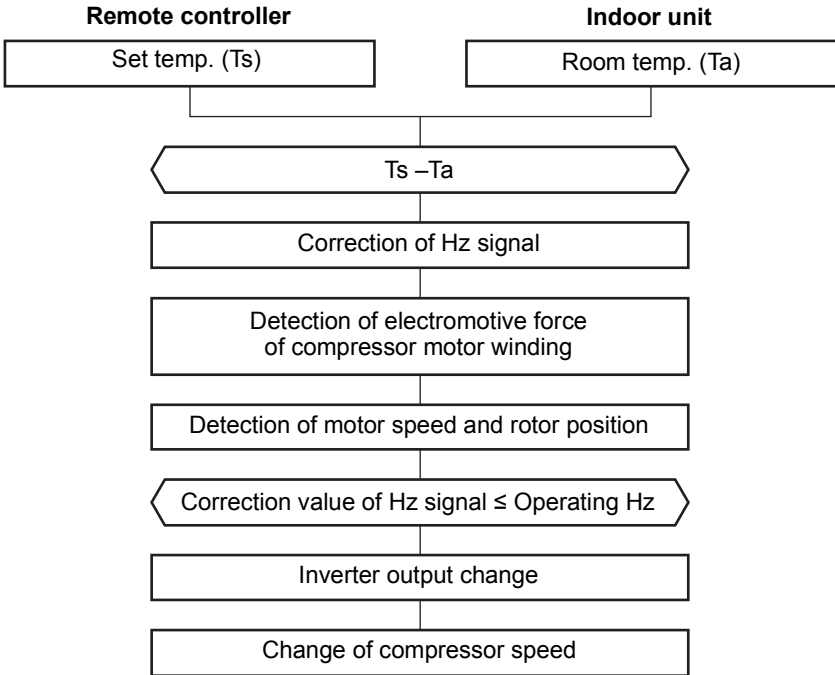
Item	Operation flow and applicable data, etc.	Description																
<p><b>1. Basic operation</b></p>	<p><b>1-5. AUTO operation</b></p> <table border="1" data-bbox="363 286 1061 1227"> <thead> <tr> <th data-bbox="363 286 651 349">Remote controller command</th> <th data-bbox="651 286 1061 349">Control outline</th> </tr> </thead> <tbody> <tr> <td data-bbox="363 349 651 1227" style="text-align: center; vertical-align: middle;"> <p>AUTO</p> </td> <td data-bbox="651 349 1061 1227"> <ul style="list-style-type: none"> <li>• COOL/HEAT operation mode is automatically selected by Ta, Ts and To for operation.</li> <li>• The operation is performed as shown in the following figure according to Ta value at the first time only. (In the range of <math>T_s + \alpha</math> <math>-1 &lt; T_a &lt; T_s + \alpha + 1</math>, Cooling thermo. OFF (Fan)/Setup air volume operation continues.)</li> </ul>  <ul style="list-style-type: none"> <li>• <math>\alpha</math> is corrected according to the outside temperature.</li> </ul> <table border="1" data-bbox="387 1010 1043 1205"> <thead> <tr> <th data-bbox="387 1010 619 1048">Outside temp.</th> <th data-bbox="619 1010 1043 1048">Correction value (<math>\alpha</math>)</th> </tr> </thead> <tbody> <tr> <td data-bbox="387 1048 619 1077">No To</td> <td data-bbox="619 1048 1043 1077">0K</td> </tr> <tr> <td data-bbox="387 1077 619 1106"><math>T_o \geq 24^\circ\text{C}</math></td> <td data-bbox="619 1077 1043 1106">-1K</td> </tr> <tr> <td data-bbox="387 1106 619 1135"><math>24 &gt; T_o \geq 18^\circ\text{C}</math></td> <td data-bbox="619 1106 1043 1135">0K</td> </tr> <tr> <td data-bbox="387 1135 619 1164"><math>T_o &lt; 18^\circ\text{C}</math></td> <td data-bbox="619 1135 1043 1164">+1K</td> </tr> <tr> <td data-bbox="387 1164 619 1205">To error</td> <td data-bbox="619 1164 1043 1205">0K</td> </tr> </tbody> </table> </td> </tr> </tbody> </table>	Remote controller command	Control outline	<p>AUTO</p>	<ul style="list-style-type: none"> <li>• COOL/HEAT operation mode is automatically selected by Ta, Ts and To for operation.</li> <li>• The operation is performed as shown in the following figure according to Ta value at the first time only. (In the range of <math>T_s + \alpha</math> <math>-1 &lt; T_a &lt; T_s + \alpha + 1</math>, Cooling thermo. OFF (Fan)/Setup air volume operation continues.)</li> </ul>  <ul style="list-style-type: none"> <li>• <math>\alpha</math> is corrected according to the outside temperature.</li> </ul> <table border="1" data-bbox="387 1010 1043 1205"> <thead> <tr> <th data-bbox="387 1010 619 1048">Outside temp.</th> <th data-bbox="619 1010 1043 1048">Correction value (<math>\alpha</math>)</th> </tr> </thead> <tbody> <tr> <td data-bbox="387 1048 619 1077">No To</td> <td data-bbox="619 1048 1043 1077">0K</td> </tr> <tr> <td data-bbox="387 1077 619 1106"><math>T_o \geq 24^\circ\text{C}</math></td> <td data-bbox="619 1077 1043 1106">-1K</td> </tr> <tr> <td data-bbox="387 1106 619 1135"><math>24 &gt; T_o \geq 18^\circ\text{C}</math></td> <td data-bbox="619 1106 1043 1135">0K</td> </tr> <tr> <td data-bbox="387 1135 619 1164"><math>T_o &lt; 18^\circ\text{C}</math></td> <td data-bbox="619 1135 1043 1164">+1K</td> </tr> <tr> <td data-bbox="387 1164 619 1205">To error</td> <td data-bbox="619 1164 1043 1205">0K</td> </tr> </tbody> </table>	Outside temp.	Correction value ( $\alpha$ )	No To	0K	$T_o \geq 24^\circ\text{C}$	-1K	$24 > T_o \geq 18^\circ\text{C}$	0K	$T_o < 18^\circ\text{C}$	+1K	To error	0K	<p>Ta: Room temp. Ts: Setup temp. To: Outside temp.</p> <p>k = deg</p>
Remote controller command	Control outline																	
<p>AUTO</p>	<ul style="list-style-type: none"> <li>• COOL/HEAT operation mode is automatically selected by Ta, Ts and To for operation.</li> <li>• The operation is performed as shown in the following figure according to Ta value at the first time only. (In the range of <math>T_s + \alpha</math> <math>-1 &lt; T_a &lt; T_s + \alpha + 1</math>, Cooling thermo. OFF (Fan)/Setup air volume operation continues.)</li> </ul>  <ul style="list-style-type: none"> <li>• <math>\alpha</math> is corrected according to the outside temperature.</li> </ul> <table border="1" data-bbox="387 1010 1043 1205"> <thead> <tr> <th data-bbox="387 1010 619 1048">Outside temp.</th> <th data-bbox="619 1010 1043 1048">Correction value (<math>\alpha</math>)</th> </tr> </thead> <tbody> <tr> <td data-bbox="387 1048 619 1077">No To</td> <td data-bbox="619 1048 1043 1077">0K</td> </tr> <tr> <td data-bbox="387 1077 619 1106"><math>T_o \geq 24^\circ\text{C}</math></td> <td data-bbox="619 1077 1043 1106">-1K</td> </tr> <tr> <td data-bbox="387 1106 619 1135"><math>24 &gt; T_o \geq 18^\circ\text{C}</math></td> <td data-bbox="619 1106 1043 1135">0K</td> </tr> <tr> <td data-bbox="387 1135 619 1164"><math>T_o &lt; 18^\circ\text{C}</math></td> <td data-bbox="619 1135 1043 1164">+1K</td> </tr> <tr> <td data-bbox="387 1164 619 1205">To error</td> <td data-bbox="619 1164 1043 1205">0K</td> </tr> </tbody> </table>	Outside temp.	Correction value ( $\alpha$ )	No To	0K	$T_o \geq 24^\circ\text{C}$	-1K	$24 > T_o \geq 18^\circ\text{C}$	0K	$T_o < 18^\circ\text{C}$	+1K	To error	0K					
Outside temp.	Correction value ( $\alpha$ )																	
No To	0K																	
$T_o \geq 24^\circ\text{C}$	-1K																	
$24 > T_o \geq 18^\circ\text{C}$	0K																	
$T_o < 18^\circ\text{C}$	+1K																	
To error	0K																	
	<p>1) The judgment of selecting COOL/HEAT is carried out as shown below. When +1.5 exceeds against Tsh 10 minutes and after thermo. -OFF, heating operation (Thermo. OFF) exchanges to cooling operation. Description in the parentheses shows an example of cooling ON/OFF.</p>  <p>When -1.5 lowers against Tsc 10 minutes and after thermo. OFF, cooling operation (Thermo. OFF) exchanges to heating operation.</p> <p>2) For the automatic capacity control after judgment of cooling/heating, see Item 4.</p> <p>3) For temperature correction of room temp. control in automatic heating, see Item 3.</p>	<p>Tsc: Setup temp. in cooling operation Tsh: Setup temp. in heating operation + temp. correction of room temp. control</p>																
	<p><b>1-6. DRY operation</b> DRY operation is aimed to dehumidification. In order to prevent lowering of the room temperature,</p> <ul style="list-style-type: none"> <li>• Indoor fan speed is fixed to cooling L tap.</li> <li>• Cooling capacity is restricted to low. When the room temperature is lower than the setup temperature, the compressor is turned off.</li> </ul>																	

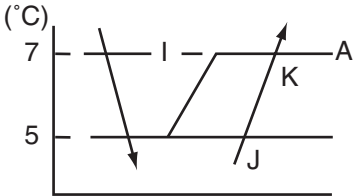
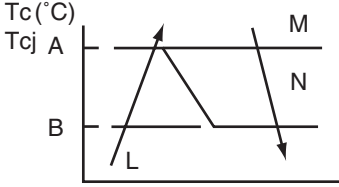
Item	Operation flow and applicable data, etc.	Description
<p><b>2. Indoor fan motor control</b></p>	<p>1) Operation with (HH), (H+), (H), (L+), (L) or [AUTO] mode is carried out by the command from the remote controller.</p> <p>2) When the air speed mode [AUTO] is selected, the air speed varies by the difference between Ta and Ts.</p> <p><b>&lt;COOL&gt;</b></p> <p>• Controlling operation in case when thermo of remote controller works is same as a case when thermo of the body works.</p> <p>• If the air speed has been changed once, it is not changed for 3 minutes. However when the air volume is exchanged, the air speed changes.</p> <p>• When cooling operation has started, select a downward slope for the air speed, that is, the high position.</p> <p>• If the temperature is just on the difference boundary, the air speed does not change.</p> <p>• Mode in the parentheses indicates one in automatic cooling operation.</p> <p><b>&lt;HEAT&gt;</b></p> <p>Value in the parentheses indicates one when thermostat of the remote controller works.</p> <p>Value without parentheses indicates one when thermostat of the body works.</p> <p>• If the air speed has been changed once, it is not changed for 1 minute. However when the air speed is exchanged, the air speed changes.</p> <p>• When heating operation has started, select an upward slope for the air speed, that is, the high position.</p> <p>• If the temperature is just on the difference boundary, the air speed does not change.</p> <p>• Mode in the parentheses indicates one in automatic heating operation.</p> <p>• In <math>T_c \geq 60^\circ\text{C}</math>, the air speed increases by 1 step.</p>	<p>HH &gt; H+ &gt; H &gt; L+ &gt; L &gt; UL</p> <p>Tc: Indoor heat exchanger sensor temperature</p>



Item	Operation flow and applicable data, etc.	Description																																																																																																																																																																																																																																																																																																																		
<b>2. Indoor fan motor control</b>	<p>Revolution speed of indoor fan (rpm)</p> <p>■ <b>07, 10 type</b></p> <table border="1" data-bbox="360 304 1085 763"> <thead> <tr> <th rowspan="2">tap</th> <th rowspan="2">COOL</th> <th rowspan="2">HEAT</th> <th colspan="4">External static pressure selection</th> </tr> <tr> <th>10Pa</th> <th>20Pa</th> <th>35Pa</th> <th>45Pa</th> </tr> </thead> <tbody> <tr><td>F1</td><td></td><td>HH</td><td>1020</td><td>1120</td><td>1200</td><td>1260</td></tr> <tr><td>F2</td><td>HH</td><td></td><td>1020</td><td>1120</td><td>1200</td><td>1260</td></tr> <tr><td>F3</td><td></td><td>H+</td><td>960</td><td>1020</td><td>1120</td><td>1160</td></tr> <tr><td>F4</td><td>H+</td><td></td><td>960</td><td>1020</td><td>1120</td><td>1160</td></tr> <tr><td>F5</td><td></td><td>H</td><td>880</td><td>940</td><td>1020</td><td>1040</td></tr> <tr><td>F6</td><td>H</td><td></td><td>880</td><td>940</td><td>1020</td><td>1040</td></tr> <tr><td>F7</td><td></td><td>L+</td><td>820</td><td>870</td><td>940</td><td>980</td></tr> <tr><td>F8</td><td>L+</td><td></td><td>820</td><td>870</td><td>940</td><td>980</td></tr> <tr><td>F9</td><td></td><td>L</td><td>740</td><td>780</td><td>850</td><td>890</td></tr> <tr><td>FA</td><td>L</td><td></td><td>740</td><td>780</td><td>850</td><td>890</td></tr> <tr><td>FB</td><td></td><td></td><td>730</td><td>730</td><td>770</td><td>820</td></tr> <tr><td>FC</td><td></td><td></td><td>730</td><td>730</td><td>770</td><td>820</td></tr> <tr><td>FD</td><td>LL</td><td>LL</td><td>610</td><td>610</td><td>610</td><td>610</td></tr> </tbody> </table> <p>■ <b>13 type</b></p> <table border="1" data-bbox="360 826 1085 1285"> <thead> <tr> <th rowspan="2">tap</th> <th rowspan="2">COOL</th> <th rowspan="2">HEAT</th> <th colspan="4">External static pressure selection</th> </tr> <tr> <th>10Pa</th> <th>20Pa</th> <th>35Pa</th> <th>45Pa</th> </tr> </thead> <tbody> <tr><td>F1</td><td></td><td>HH</td><td>1120</td><td>1160</td><td>1240</td><td>1300</td></tr> <tr><td>F2</td><td>HH</td><td></td><td>1120</td><td>1160</td><td>1240</td><td>1300</td></tr> <tr><td>F3</td><td></td><td>H+</td><td>1000</td><td>1040</td><td>1140</td><td>1200</td></tr> <tr><td>F4</td><td>H+</td><td></td><td>1000</td><td>1040</td><td>1140</td><td>1200</td></tr> <tr><td>F5</td><td></td><td>H</td><td>920</td><td>970</td><td>1040</td><td>1120</td></tr> <tr><td>F6</td><td>H</td><td></td><td>920</td><td>970</td><td>1040</td><td>1120</td></tr> <tr><td>F7</td><td></td><td>L+</td><td>830</td><td>870</td><td>930</td><td>980</td></tr> <tr><td>F8</td><td>L+</td><td></td><td>830</td><td>870</td><td>930</td><td>980</td></tr> <tr><td>F9</td><td></td><td>L</td><td>740</td><td>780</td><td>840</td><td>870</td></tr> <tr><td>FA</td><td>L</td><td></td><td>740</td><td>780</td><td>840</td><td>870</td></tr> <tr><td>FB</td><td></td><td></td><td>730</td><td>730</td><td>770</td><td>820</td></tr> <tr><td>FC</td><td></td><td></td><td>730</td><td>730</td><td>770</td><td>820</td></tr> <tr><td>FD</td><td>LL</td><td>LL</td><td>610</td><td>610</td><td>610</td><td>610</td></tr> </tbody> </table> <p>■ <b>16 type</b></p> <table border="1" data-bbox="360 1348 1085 1807"> <thead> <tr> <th rowspan="2">tap</th> <th rowspan="2">COOL</th> <th rowspan="2">HEAT</th> <th colspan="4">External static pressure selection</th> </tr> <tr> <th>10Pa</th> <th>20Pa</th> <th>35Pa</th> <th>45Pa</th> </tr> </thead> <tbody> <tr><td>F1</td><td></td><td>HH</td><td>1020</td><td>1120</td><td>1220</td><td>1260</td></tr> <tr><td>F2</td><td>HH</td><td></td><td>1020</td><td>1120</td><td>1220</td><td>1260</td></tr> <tr><td>F3</td><td></td><td>H+</td><td>960</td><td>970</td><td>1100</td><td>1140</td></tr> <tr><td>F4</td><td>H+</td><td></td><td>960</td><td>970</td><td>1100</td><td>1140</td></tr> <tr><td>F5</td><td></td><td>H</td><td>810</td><td>810</td><td>960</td><td>1020</td></tr> <tr><td>F6</td><td>H</td><td></td><td>810</td><td>810</td><td>960</td><td>1020</td></tr> <tr><td>F7</td><td></td><td>L+</td><td>730</td><td>750</td><td>810</td><td>960</td></tr> <tr><td>F8</td><td>L+</td><td></td><td>720</td><td>750</td><td>810</td><td>960</td></tr> <tr><td>F9</td><td></td><td>L</td><td>660</td><td>700</td><td>760</td><td>800</td></tr> <tr><td>FA</td><td>L</td><td></td><td>630</td><td>670</td><td>720</td><td>760</td></tr> <tr><td>FB</td><td></td><td></td><td>630</td><td>630</td><td>660</td><td>680</td></tr> <tr><td>FC</td><td></td><td></td><td>630</td><td>630</td><td>640</td><td>660</td></tr> <tr><td>FD</td><td>LL</td><td>LL</td><td>550</td><td>550</td><td>550</td><td>550</td></tr> </tbody> </table>	tap	COOL	HEAT	External static pressure selection				10Pa	20Pa	35Pa	45Pa	F1		HH	1020	1120	1200	1260	F2	HH		1020	1120	1200	1260	F3		H+	960	1020	1120	1160	F4	H+		960	1020	1120	1160	F5		H	880	940	1020	1040	F6	H		880	940	1020	1040	F7		L+	820	870	940	980	F8	L+		820	870	940	980	F9		L	740	780	850	890	FA	L		740	780	850	890	FB			730	730	770	820	FC			730	730	770	820	FD	LL	LL	610	610	610	610	tap	COOL	HEAT	External static pressure selection				10Pa	20Pa	35Pa	45Pa	F1		HH	1120	1160	1240	1300	F2	HH		1120	1160	1240	1300	F3		H+	1000	1040	1140	1200	F4	H+		1000	1040	1140	1200	F5		H	920	970	1040	1120	F6	H		920	970	1040	1120	F7		L+	830	870	930	980	F8	L+		830	870	930	980	F9		L	740	780	840	870	FA	L		740	780	840	870	FB			730	730	770	820	FC			730	730	770	820	FD	LL	LL	610	610	610	610	tap	COOL	HEAT	External static pressure selection				10Pa	20Pa	35Pa	45Pa	F1		HH	1020	1120	1220	1260	F2	HH		1020	1120	1220	1260	F3		H+	960	970	1100	1140	F4	H+		960	970	1100	1140	F5		H	810	810	960	1020	F6	H		810	810	960	1020	F7		L+	730	750	810	960	F8	L+		720	750	810	960	F9		L	660	700	760	800	FA	L		630	670	720	760	FB			630	630	660	680	FC			630	630	640	660	FD	LL	LL	550	550	550	550	<p>Tcj: Indoor heat exchanger sensor temperature</p>
tap	COOL				HEAT	External static pressure selection																																																																																																																																																																																																																																																																																																														
		10Pa	20Pa	35Pa		45Pa																																																																																																																																																																																																																																																																																																														
F1		HH	1020	1120	1200	1260																																																																																																																																																																																																																																																																																																														
F2	HH		1020	1120	1200	1260																																																																																																																																																																																																																																																																																																														
F3		H+	960	1020	1120	1160																																																																																																																																																																																																																																																																																																														
F4	H+		960	1020	1120	1160																																																																																																																																																																																																																																																																																																														
F5		H	880	940	1020	1040																																																																																																																																																																																																																																																																																																														
F6	H		880	940	1020	1040																																																																																																																																																																																																																																																																																																														
F7		L+	820	870	940	980																																																																																																																																																																																																																																																																																																														
F8	L+		820	870	940	980																																																																																																																																																																																																																																																																																																														
F9		L	740	780	850	890																																																																																																																																																																																																																																																																																																														
FA	L		740	780	850	890																																																																																																																																																																																																																																																																																																														
FB			730	730	770	820																																																																																																																																																																																																																																																																																																														
FC			730	730	770	820																																																																																																																																																																																																																																																																																																														
FD	LL	LL	610	610	610	610																																																																																																																																																																																																																																																																																																														
tap	COOL	HEAT	External static pressure selection																																																																																																																																																																																																																																																																																																																	
			10Pa	20Pa	35Pa	45Pa																																																																																																																																																																																																																																																																																																														
F1		HH	1120	1160	1240	1300																																																																																																																																																																																																																																																																																																														
F2	HH		1120	1160	1240	1300																																																																																																																																																																																																																																																																																																														
F3		H+	1000	1040	1140	1200																																																																																																																																																																																																																																																																																																														
F4	H+		1000	1040	1140	1200																																																																																																																																																																																																																																																																																																														
F5		H	920	970	1040	1120																																																																																																																																																																																																																																																																																																														
F6	H		920	970	1040	1120																																																																																																																																																																																																																																																																																																														
F7		L+	830	870	930	980																																																																																																																																																																																																																																																																																																														
F8	L+		830	870	930	980																																																																																																																																																																																																																																																																																																														
F9		L	740	780	840	870																																																																																																																																																																																																																																																																																																														
FA	L		740	780	840	870																																																																																																																																																																																																																																																																																																														
FB			730	730	770	820																																																																																																																																																																																																																																																																																																														
FC			730	730	770	820																																																																																																																																																																																																																																																																																																														
FD	LL	LL	610	610	610	610																																																																																																																																																																																																																																																																																																														
tap	COOL	HEAT	External static pressure selection																																																																																																																																																																																																																																																																																																																	
			10Pa	20Pa	35Pa	45Pa																																																																																																																																																																																																																																																																																																														
F1		HH	1020	1120	1220	1260																																																																																																																																																																																																																																																																																																														
F2	HH		1020	1120	1220	1260																																																																																																																																																																																																																																																																																																														
F3		H+	960	970	1100	1140																																																																																																																																																																																																																																																																																																														
F4	H+		960	970	1100	1140																																																																																																																																																																																																																																																																																																														
F5		H	810	810	960	1020																																																																																																																																																																																																																																																																																																														
F6	H		810	810	960	1020																																																																																																																																																																																																																																																																																																														
F7		L+	730	750	810	960																																																																																																																																																																																																																																																																																																														
F8	L+		720	750	810	960																																																																																																																																																																																																																																																																																																														
F9		L	660	700	760	800																																																																																																																																																																																																																																																																																																														
FA	L		630	670	720	760																																																																																																																																																																																																																																																																																																														
FB			630	630	660	680																																																																																																																																																																																																																																																																																																														
FC			630	630	640	660																																																																																																																																																																																																																																																																																																														
FD	LL	LL	550	550	550	550																																																																																																																																																																																																																																																																																																														

Item	Operation flow and applicable data, etc.						Description																																																																																																					
<b>2. Indoor fan motor control</b>	<b>■ 22 type</b>						[Self-clean  ] is displayed.																																																																																																					
	<table border="1"> <thead> <tr> <th rowspan="2">tap</th> <th rowspan="2">COOL</th> <th rowspan="2">HEAT</th> <th colspan="4">External static pressure selection</th> </tr> <tr> <th>10Pa</th> <th>20Pa</th> <th>35Pa</th> <th>45Pa</th> </tr> </thead> <tbody> <tr><td>F1</td><td></td><td>HH</td><td>1080</td><td>1140</td><td>1240</td><td>1280</td></tr> <tr><td>F2</td><td>HH</td><td></td><td>1080</td><td>1140</td><td>1240</td><td>1280</td></tr> <tr><td>F3</td><td></td><td>H+</td><td>1020</td><td>1080</td><td>1180</td><td>1220</td></tr> <tr><td>F4</td><td>H+</td><td></td><td>1020</td><td>1080</td><td>1180</td><td>1220</td></tr> <tr><td>F5</td><td></td><td>H</td><td>950</td><td>1020</td><td>1100</td><td>1160</td></tr> <tr><td>F6</td><td>H</td><td></td><td>950</td><td>1020</td><td>1100</td><td>1160</td></tr> <tr><td>F7</td><td></td><td>L+</td><td>890</td><td>960</td><td>1040</td><td>1100</td></tr> <tr><td>F8</td><td>L+</td><td></td><td>890</td><td>960</td><td>1040</td><td>1100</td></tr> <tr><td>F9</td><td></td><td>L</td><td>830</td><td>890</td><td>970</td><td>1020</td></tr> <tr><td>FA</td><td>L</td><td></td><td>830</td><td>890</td><td>970</td><td>1020</td></tr> <tr><td>FB</td><td></td><td>L-</td><td>690</td><td>720</td><td>760</td><td>790</td></tr> <tr><td>FC</td><td>L-</td><td></td><td>690</td><td>720</td><td>760</td><td>790</td></tr> <tr><td>FD</td><td>LL</td><td>LL</td><td>550</td><td>550</td><td>550</td><td>550</td></tr> </tbody> </table>							tap	COOL	HEAT	External static pressure selection				10Pa	20Pa	35Pa	45Pa	F1		HH	1080	1140	1240	1280	F2	HH		1080	1140	1240	1280	F3		H+	1020	1080	1180	1220	F4	H+		1020	1080	1180	1220	F5		H	950	1020	1100	1160	F6	H		950	1020	1100	1160	F7		L+	890	960	1040	1100	F8	L+		890	960	1040	1100	F9		L	830	890	970	1020	FA	L		830	890	970	1020	FB		L-	690	720	760	790	FC	L-		690	720	760	790	FD	LL	LL	550	550	550
tap	COOL	HEAT	External static pressure selection																																																																																																									
			10Pa	20Pa	35Pa	45Pa																																																																																																						
F1		HH	1080	1140	1240	1280																																																																																																						
F2	HH		1080	1140	1240	1280																																																																																																						
F3		H+	1020	1080	1180	1220																																																																																																						
F4	H+		1020	1080	1180	1220																																																																																																						
F5		H	950	1020	1100	1160																																																																																																						
F6	H		950	1020	1100	1160																																																																																																						
F7		L+	890	960	1040	1100																																																																																																						
F8	L+		890	960	1040	1100																																																																																																						
F9		L	830	890	970	1020																																																																																																						
FA	L		830	890	970	1020																																																																																																						
FB		L-	690	720	760	790																																																																																																						
FC	L-		690	720	760	790																																																																																																						
FD	LL	LL	550	550	550	550																																																																																																						
<b>■ 24 type</b>																																																																																																												
<table border="1"> <thead> <tr> <th rowspan="2">tap</th> <th rowspan="2">COOL</th> <th rowspan="2">HEAT</th> <th colspan="4">External static pressure selection</th> </tr> <tr> <th>10Pa</th> <th>20Pa</th> <th>35Pa</th> <th>45Pa</th> </tr> </thead> <tbody> <tr><td>F1</td><td></td><td>HH</td><td>1120</td><td>1180</td><td>1280</td><td>1300</td></tr> <tr><td>F2</td><td>HH</td><td></td><td>1120</td><td>1180</td><td>1280</td><td>1300</td></tr> <tr><td>F3</td><td></td><td>H+</td><td>1060</td><td>1120</td><td>1200</td><td>1260</td></tr> <tr><td>F4</td><td>H+</td><td></td><td>1060</td><td>1120</td><td>1200</td><td>1260</td></tr> <tr><td>F5</td><td></td><td>H</td><td>980</td><td>1040</td><td>1120</td><td>1180</td></tr> <tr><td>F6</td><td>H</td><td></td><td>980</td><td>1040</td><td>1120</td><td>1180</td></tr> <tr><td>F7</td><td></td><td>L+</td><td>920</td><td>980</td><td>1060</td><td>1100</td></tr> <tr><td>F8</td><td>L+</td><td></td><td>920</td><td>980</td><td>1060</td><td>1100</td></tr> <tr><td>F9</td><td></td><td>L</td><td>840</td><td>900</td><td>980</td><td>1020</td></tr> <tr><td>FA</td><td>L</td><td></td><td>840</td><td>900</td><td>980</td><td>1020</td></tr> <tr><td>FB</td><td></td><td></td><td>700</td><td>730</td><td>770</td><td>790</td></tr> <tr><td>FC</td><td></td><td></td><td>700</td><td>730</td><td>770</td><td>790</td></tr> <tr><td>FD</td><td>LL</td><td>LL</td><td>550</td><td>550</td><td>550</td><td>610</td></tr> </tbody> </table>						tap	COOL	HEAT	External static pressure selection				10Pa	20Pa	35Pa	45Pa	F1		HH	1120	1180	1280	1300	F2	HH		1120	1180	1280	1300	F3		H+	1060	1120	1200	1260	F4	H+		1060	1120	1200	1260	F5		H	980	1040	1120	1180	F6	H		980	1040	1120	1180	F7		L+	920	980	1060	1100	F8	L+		920	980	1060	1100	F9		L	840	900	980	1020	FA	L		840	900	980	1020	FB			700	730	770	790	FC			700	730	770	790	FD	LL	LL	550	550	550	610	
tap	COOL	HEAT	External static pressure selection																																																																																																									
			10Pa	20Pa	35Pa	45Pa																																																																																																						
F1		HH	1120	1180	1280	1300																																																																																																						
F2	HH		1120	1180	1280	1300																																																																																																						
F3		H+	1060	1120	1200	1260																																																																																																						
F4	H+		1060	1120	1200	1260																																																																																																						
F5		H	980	1040	1120	1180																																																																																																						
F6	H		980	1040	1120	1180																																																																																																						
F7		L+	920	980	1060	1100																																																																																																						
F8	L+		920	980	1060	1100																																																																																																						
F9		L	840	900	980	1020																																																																																																						
FA	L		840	900	980	1020																																																																																																						
FB			700	730	770	790																																																																																																						
FC			700	730	770	790																																																																																																						
FD	LL	LL	550	550	550	610																																																																																																						
<p>3) In heating operation, the mode changes to [LL] if thermostat is turned off.</p> <p>4) If <math>T_a \geq 25^\circ\text{C}</math> when heating operation has started and when defrost operation has been cleared, the air conditioner operates with (H) mode or higher mode for 1 minute after <math>T_c</math> entered in E zone of cool air discharge preventive control.</p> <p>5) Self-clean operation  When performing self-clean operation after stopping the cooling operation, the mode becomes 610 rpm (M07, 10, 13, 24 type), 630 rpm (M16, 22 type).</p>																																																																																																												

Item	Operation flow and applicable data, etc.	Description
<p><b>2. Indoor fan motor control</b></p>	<p>Cool air discharge preventive control</p> <p>1) In heating operation, the indoor fan is controlled based on the detected temperature of Tc sensor or Tcj sensor. As shown below, the upper limit of the revolution frequency is restricted.</p> <p>However B zone is assumed as C zone for 6 minutes and after when the compressor activated. In defrost operation, the control value of Tc is shifted by 6°C.</p> 	<p>In D and E zones, the priority is given to air volume selection setup of remote controller.</p> <p>In A zone while thermo is ON, [PRE-HEAT ⚙️ (Heating ready)] is displayed.</p>
<p><b>3. Capacity control</b></p>	<p>The cooling or heating capacity depending on the load is adjusted. According to difference between the setup value of temperature and the room temperature, the capacity is adjusted by the compressor revolution.</p> 	<ol style="list-style-type: none"> <li>1) The difference between set temperature on remote controller (Ts) and room temperature (Ta) is calculated.</li> <li>2) According to the temperature difference, the correction value of Hz signal which determines the compressor speed is set up.</li> <li>3) The rotating position and speed of the motor are detected by the electromotive force occurred on the motor winding with operation of the compressor.</li> <li>4) According to the difference resulted from comparison of the correction value of Hz signal with the present operation Hz, the inverter output is varied.</li> <li>5) Change the compressor motor speed by outputting power to the compressor.</li> </ol> <p>* The contents of control operation are same in cooling operation and heating operation</p>

Item	Operation flow and applicable data, etc.	Description						
<p><b>4. Release protective control by temperature of indoor heat exchanger</b></p>	<p>Freeze preventive control (Low temperature release)</p> <p>1) The cooling operation (including Dry operation) is performed as follows based on the detected temperature of Tc sensor or Tcj sensor.</p> <p>When [J] zone is detected for 6 minutes (Following figure), the commanded frequency is decreased from the real operation frequency.</p> <p>After then the commanded frequency changes every 30 seconds while operation is performed in [J] zone.</p> <p>In [K] zone, time counting is interrupted and the operation is held.</p> <p>When [ I ] zone is detected, the timer is cleared and the operation returns to the normal operation.</p> <p>If the commanded frequency becomes S0 because the operation continues in [J] zone, the return temperature A is raised from 7°C to 12°C until [ I ] zone is detected and the indoor fan operates with [L] mode.</p> 	<p>Tcj: Indoor heat exchanger sensor temperature</p>						
	<p>High-temp. release control</p> <p>1) The heating operation is performed as follows based on the detected temperature of Tc sensor or Tcj sensor.</p> <ul style="list-style-type: none"> <li>• When [M] zone is detected, the commanded frequency is decreased from the real operation frequency. After then the commanded frequency changes every 30 seconds while operation is performed in [M] zone.</li> <li>• In [N] zone, the commanded frequency is held.</li> <li>• When [L] zone is detected, the commanded frequency is returned to the original value by approx. 6Hz every 60 seconds.</li> </ul> <p><b>Setup at shipment</b></p> <table border="1" data-bbox="344 1447 585 1547"> <thead> <tr> <th colspan="2">Control temp. (°C)</th> </tr> <tr> <th>A</th> <th>B</th> </tr> </thead> <tbody> <tr> <td>53 (51)</td> <td>51 (49)</td> </tr> </tbody> </table>  <p><b>NOTE:</b> When the operation has started or when Tc or Tcj &lt; 30°C at start of the operation or after operation start, temperature is controlled between values in parentheses of A and B.</p>	Control temp. (°C)		A	B	53 (51)	51 (49)	<p>Same status as that when “thermostat-OFF” (status that the air conditioner enters in the room temp. monitor mode when the temperature reached the setup temperature on the remote controller)</p>
Control temp. (°C)								
A	B							
53 (51)	51 (49)							

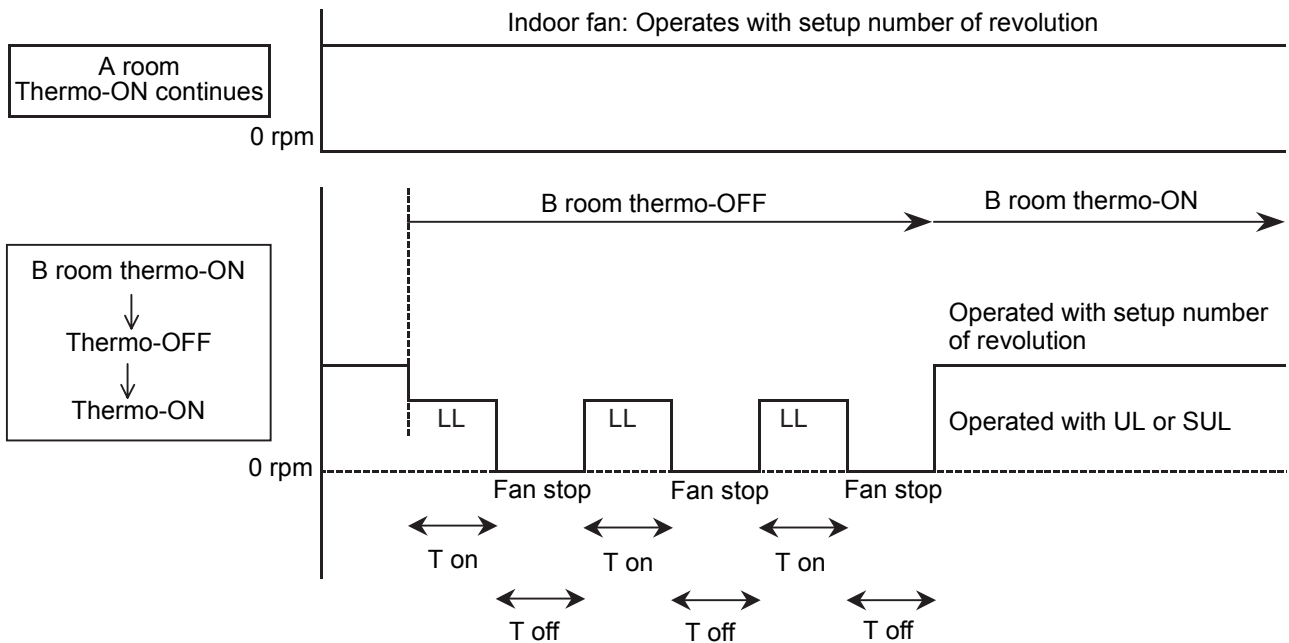
Item	Operation flow and applicable data, etc.	Description
<b>5. Drain pump control</b>	1) In cooling operation (including Dry operation), the drain pump is usually operated. 2) If the float switch works while drain pump drives, the compressor stops, the drain pump continues the operation, and a check code is output. 3) If the float switch works while drain pump stops, the compressor stops and the drain pump operates. If the float switch keeps operating for approx. 4 minutes, a check code is output. 4) The drain pump doesn't stop immediately to decrease the drain water in the drain pan when the cooling operation (including Dry operation) was stopped and drive the drain pump for five minutes.	Check code [OB]
<b>6. After-heat elimination</b>	When heating operation stops, in some cases, the indoor fan operates with [LL] for approx. 30 seconds.	

## 7. Intermittent Operation Control for Indoor Fans of the Indoor Unit at Thermo-off Side in Heating Operation

While heating operation is executed in two rooms, if room temperature reached the setup temperature in one room and thermo-off occurred, the following operations start. (Refer to the figure below.)

1. The indoor unit of the room (A room) in which thermo-off did not occur starts a continuous operation with the setup number of revolution.
2. The indoor unit of the room (B room) in which thermo-off occurred starts intermittent operation of the indoor fan. The indoor fan operates with number of revolution of LL. Fan-ON time is 2 minutes and Fan-OFF time is 2 to 4 minutes.

While heating operation is executed in two rooms, if room temperature reached the setup temperature in both room had thermo-off occurred, both indoor units start intermittent operation of the indoor fan.



T on=2 min.

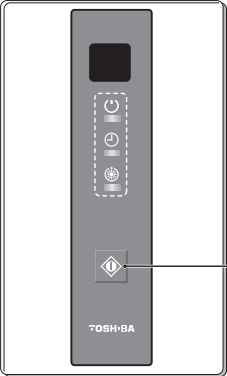
T off time	
To < 5°C	2 min.
5 ≤ To < 10	3 min.
10 ≤ To	4 min.

## 8. Additional Operation

Item	Operation flow and applicable data, etc.	Description
<b>8-1. QUIET mode</b>	When the [QUIET] button is pressed, the fan of the indoor unit will be restricted the revolving speed at speed L until the [QUIET] button is pressed once again (cancel Quiet mode).	Quiet mode is the system which, control the revolving speed of indoor fan to work constantly at speed L.  Remarks : 1. Quiet mode is unable to work in dry mode. 2. Quiet mode is appropriate to work with less cooling load and less heating load condition. Because of the fan speed L may cause not enough the cooling capacity or heating capacity.
<b>8-2. Hi-POWER Mode</b>	<p><b>([Hi-POWER] button on the remote controller is pressed)</b></p> When [Hi-POWER] button is pressed while the indoor unit is in Auto, Cooling or Heating operation, Hi-POWER mark is indicated on the display of the remote controller and the unit operates as follows. <p><b>1. Automatic operation</b></p> <ul style="list-style-type: none"> <li>• The indoor unit operates in according to the current operation.</li> </ul> <p><b>2. Cooling operation</b></p> <ul style="list-style-type: none"> <li>• The preset temperature drops 1°C (The value of the preset temperature on the remote controller does not change.)</li> </ul> <p><b>3. Heating operation</b></p> <ul style="list-style-type: none"> <li>• The preset temperature increases 2°C (The value of the preset temperature on the remote controller does not change.)</li> </ul> <p><b>4. The Hi-POWER mode can not be set in Dry operation</b></p>	
<b>8-3. ECO mode</b>	When pressing [ECO] button on the remote controller, a Economic operation is performed.	1) Temperature control Cooling operation The control target temperature increase 1°C per hour up to 2°C starting from the set temperature when ECO has been received. Heating operation The control target temperature decrease 1°C per hour up to 2°C starting from the set temperature when ECO has been received. 2) The indoor fan speed : presetting [AUTO] fan speed changes to L, [MANUAL] fan speed does not change. 3) Compressor speed is restricted to silent mode max. Hz.

Item	Operation flow and applicable data, etc.	Description
<b>8-4. COMFORT SLEEP mode</b>	<p><b>Cooling mode</b></p> <ul style="list-style-type: none"> <li>The preset temperature will increase as ECO operation (Item 8-3.)</li> <li>Press the [COMFORT SLEEP] button to choose the operating hours. Repeat pressing to select the hours. (1hr, 3hr, 5hr or 9hr)</li> <li>If the [COMFORT SLEEP] button is pressed again means cancel comfort sleep mode.</li> </ul> <p><b>Heating mode</b></p> <ul style="list-style-type: none"> <li>The preset temperature will drop down as ECO operation (Item 8-3.)</li> <li>Press the [COMFORT SLEEP] button to choose the operating hours. Repeat pressing to select the hours. (1hr, 3hr, 5hr or 9 hr)</li> <li>If the [COMFORT SLEEP] button is pressed again means cancel comfort sleep mode.</li> </ul>	<p>The principles of comfort sleep mode are:</p> <ul style="list-style-type: none"> <li>Quietness for more comfortable.</li> <li>Save energy by changing room temperature automatically.</li> <li>The air condition can shut down by itself automatically.</li> </ul> <p>Remarks :</p> <ol style="list-style-type: none"> <li>Comfort sleep mode will not operate in dry mode and fan only mode.</li> </ol>
<b>9. One-Touch Comfort</b>	<p>One touch comfort is the fully automated operation that is set according to the preferable condition in a region.</p>	<p><b>Operation condition for model to Europe market</b></p> <p>When an indoor unit receives "One Touch Comfort Signal" from the remote controller, the indoor unit operates as following.</p> <ol style="list-style-type: none"> <li>Air conditioner starts to operation when the signal is received, even if the air conditioner was OFF.</li> <li>Operation mode is set according to room temperature, the same as AUTO mode.</li> <li>Target temperature is 24°C.</li> <li>Fan operates depends on the setting temperature and room temperature.</li> </ol>
<b>10. Temporary operation</b>	<p>When you press the [TEMPORARY] button, air conditioner works as shown below.</p> <pre> graph TD     Start{Not in operation?} -- YES --&gt; Q1{Did you press [TEMPORARY] button for 3 seconds or more?}     Start -- NO --&gt; Q2{If you pressed temporary button}     Q1 -- YES --&gt; TR1[TEST RUN(COOL) operation ("Pi" sound is heard.)]     Q1 -- NO --&gt; T1[Temporary [AUTO] operation]     Q2 -- YES --&gt; OS[Operation stops]     Q2 -- NO --&gt; Q3{Did you press [TEMPORARY] button for 3 seconds or more?}     OS --&gt; Q3     Q3 -- YES --&gt; Q4{Did you press [TEMPORARY] button for 10 seconds or more?}     Q3 -- NO --&gt; NO1[Non Operation]     Q4 -- YES --&gt; TR2[TEST RUN(COOL) operation ("Pi" sound is heard.)]     Q4 -- NO --&gt; Q5{Did you press [TEMPORARY] button for 20 seconds or more?}     Q5 -- YES --&gt; SC[Switch to [Self Cleaning] control ("Pi Pi Pi Pi Pi" sound is heard.)]     Q5 -- NO --&gt; NO2[Non Operation]     Q6{Did you press [TEMPORARY] button for 10 seconds or more?} -- YES --&gt; TR2     Q6 -- NO --&gt; AR[Switch to [AUTO RESTART] control ("Pi Pi Pi" sound is heard.)]   </pre>	

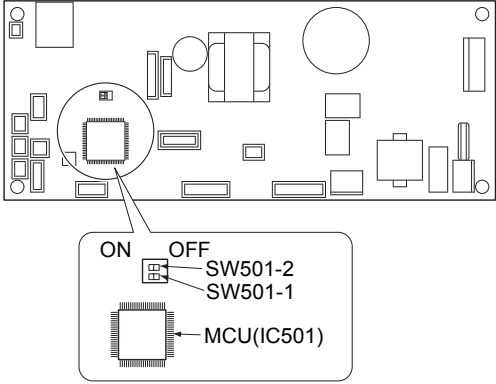


Item	Operation flow and applicable data, etc.	Description
<p><b>11. Frequency fixed operation (Test run)</b></p>	<p><b>&lt;In case of wired remote controller&gt;</b> Refer to 14-1. Test run setup.</p> <p><b>&lt;In case of wireless remote controller&gt;</b></p> <ol style="list-style-type: none"> <li>1) When TEMPORARY button is pushed for 10 seconds or more, "Pi!" sound is heard and the operation changes to test run. After approx. 3 minutes, a cooling operation starts forcedly. Check cool air starts blowing. If the operation does not start, check wiring again.</li> <li>2) To stop a test run, push TEMPORARY button once again (Approx. 1 second). Check wiring / piping of the indoor and outdoor units in test run.</li> </ol> <div style="text-align: center;">  <p><b>TEMPORARY button</b></p> </div> <ul style="list-style-type: none"> <li>• In the TEST RUN, all LEDs together keep blinking.</li> <li>• In order to prevent a serial operation, the TEST RUN mode is released after 60 minutes have passed and returns to the usual operation.</li> </ul>	<p>Command frequency is approximately [S7]</p>

Item	Operation flow and applicable data, etc.	Description													
<p><b>12. Self-Cleaning function</b></p>	<div data-bbox="225 338 895 887" data-label="Diagram"> <pre> graph TD     A[Unit now performing cooling or dry operation] --&gt; B[Press "STOP" button]     B --&gt; C[Only PRE, DEF indicator lights, and Self Cleaning operation starts]     C --&gt; D[Time set now elapses]     D --&gt; E[Operation stops]           </pre> </div> <ul style="list-style-type: none"> <li>• During Self-Cleaning operations: The indoor fan operates continuously at a speed of M07/10/13/24 : 610 rpm, M16/22: 630 rpm.</li> </ul> <div data-bbox="352 1196 671 1225" data-label="Section-Header"> <p>Self-Cleaning operation times</p> </div> <table border="1" data-bbox="352 1229 1318 1458"> <thead> <tr> <th></th> <th>Operation time</th> <th>Self-Cleaning operation time</th> </tr> </thead> <tbody> <tr> <td rowspan="2">Cooling: Auto (cooling) Dry</td> <td>Up to 10 minutes</td> <td>No Self-Cleaning operation performed (0 minutes)</td> </tr> <tr> <td>10 minutes or longer</td> <td>30 mins.</td> </tr> <tr> <td>Heating: Auto (heating)</td> <td colspan="2" rowspan="3">No Self-Cleaning operation performed</td> </tr> <tr> <td>Auto (fan only)</td> </tr> <tr> <td>Shutdown</td> </tr> </tbody> </table> <ul style="list-style-type: none"> <li>• To stop an ongoing Self-Cleaning operation at any time Press the start/stop button on the remote controller twice during the Self-Cleaning operation. (After pressing the button for the first time, press it for the second time without delay (within 10 minutes).)</li> </ul>		Operation time	Self-Cleaning operation time	Cooling: Auto (cooling) Dry	Up to 10 minutes	No Self-Cleaning operation performed (0 minutes)	10 minutes or longer	30 mins.	Heating: Auto (heating)	No Self-Cleaning operation performed		Auto (fan only)	Shutdown	<p><b>1. Purpose</b></p> <p>The Self-Cleaning operation is to minimize the growth of mold, bacteria etc. by running the fan and drying so as to keep the inside of the air conditioner clean.</p> <p><b>Self-Cleaning operation</b></p> <p>When the cooling or dry operation shuts down, the unit automatically starts the Self-Cleaning operation which is then performed for the specified period based on duration of the operation which was performed prior to the shutdown, after which the Self-Cleaning operation stops. (The Self-Cleaning operation is not performed after a heating operation.)</p> <p><b>2. Operation</b></p> <ol style="list-style-type: none"> <li>1) When the stop signal from the remote controller or timer-off function is received, only the PRE.DEF indicator light.</li> <li>2) The period of the Self-Cleaning operation is determined by the duration of the operation performed prior to the reception of the stop code.</li> <li>3) After the Self-Cleaning operation has been performed for the specified period, the unit stops operating.</li> </ol>
	Operation time	Self-Cleaning operation time													
Cooling: Auto (cooling) Dry	Up to 10 minutes	No Self-Cleaning operation performed (0 minutes)													
	10 minutes or longer	30 mins.													
Heating: Auto (heating)	No Self-Cleaning operation performed														
Auto (fan only)															
Shutdown															

Item	Operation flow and applicable data, etc.	Description	
<b>12. Self-Cleaning function</b>	<ul style="list-style-type: none"> <li>• Self-Cleaning diagram</li> </ul>		
Operation display	ON	OFF	OFF
FCU fan	ON rpm is depend on presetting.	ON (Self-Cleaning fan speed)	OFF
PRE, DEF display	OFF	ON	OFF
Compressor	ON or OFF depend on presetting per room temperature.	OFF	OFF
CDU fan	ON or OFF depend on presetting per room temperature.	OFF	OFF
<b>13. Self-Cleaning function release</b>	<p><b>How to cancel Self-Cleaning function</b></p> <p>To cancel the Self-Cleaning function, proceed as follows:</p> <ul style="list-style-type: none"> <li>• Press [TEMPORARY] button one time or use remote control to turn on air conditioner. Display will show in green color.</li> <li>• Hold down the [TEMPORARY] button for more than 20 seconds. (The air conditioner will stop suddenly when the [TEMPORARY] is pressed but keep holding it continue.</li> <li>• After holding about 20 seconds, the air conditioner will beep 5 times without any blinking of display.</li> <li>• The Self-Cleaning Operation had been cancelled.</li> </ul> <p><b>How to set Self-Cleaning function</b></p> <p>To set the Self-Cleaning function, proceed as follows.</p> <ul style="list-style-type: none"> <li>• Press [TEMPORARY] button one time or use remote control to turn on air conditioner. Display will show in green color.</li> <li>• Hold down the [TEMPORARY] button for more than 20 seconds. (The air conditioner will stop suddenly when the [TEMPORARY] is pressed but keep holding it continue.</li> <li>• After holding about 20 seconds, the air conditioner will beep 5 times and OPERATION display blinks 5 seconds.</li> <li>• The Self-Cleaning function had been set.</li> </ul>		
<b>14. Suction temperature correction</b>	<p>If difference between room temperature and Ta sensor value is big, suction temperature shift by FC code setting is available, refer to <b>14-2 Appendix Function selection setup</b>.</p>		

Item	Operation flow and applicable data, etc.	Description
<p><b>15. Remote-A or B selection</b></p>	<p><b>Setting the remote controller</b> To separate using of remote control for each indoor unit in case of 2 air conditioner are installed nearby.</p> <p><b>Remote Control B Setup.</b></p> <ol style="list-style-type: none"> <li>1) Press TEMPORARY button on the signal receiving unit to turn the air conditioner ON.</li> <li>2) Point the remote control at the signal receiving unit.</li> <li>3) Push and hold CHECK • button on the Remote Control by the tip of the pencil. "00" will be shown on the display.</li> <li>4) Press MODE • during pushing CHECK •. "B" will show on the display and "00" will disappear and the air conditioner will turn OFF. The Remote Control B is memorized.</li> </ol> <p>Note :</p> <ol style="list-style-type: none"> <li>1. Repeat above step to reset Remote Control to be A.</li> <li>2. Remote Control A has not "A" display.</li> <li>3. Default setting of Remote Control from factory is A.</li> </ol> <div data-bbox="411 902 863 1084" style="text-align: center;"> <p>The diagram shows a Toshiba remote control with a digital display. The display shows 'AB AUTO' at the top, '00' in the center, and 'PM 12:00' on the right. Two lines point to the 'B' and '00' on the display with labels: '"B" Display' and '"00" Display'.</p> </div>	<p><b>1. Purpose</b> This operation is to operate only one indoor unit using one remote controller.</p> <p><b>2. Description</b> When operating one indoor unit in a situation where two indoor units have been installed in the same room or nearby rooms, this operation prevents the remote controller signal from being received simultaneously by both units, thus preventing both units from operating.</p> <p><b>3. Operation</b> The indoor unit on which the remote controller selection has been set to B receives the signal of the remote controller also set to B. (At the factory the remote controller selection is set to A on all the indoor units. There is no A setting display.)</p>
<p><b>16. Short Timer</b></p>	<p>In the normal condition, after switching one circuit breaker, 3-minute delay time for compressor is set for the maintenance of the unit.</p> <div data-bbox="517 1391 775 1872" style="text-align: center;"> <p>The diagram shows a Toshiba remote control with various buttons. Callout 3 points to the 'CHECK' button, and callout 4 points to the 'TEMP.' button.</p> </div>	<p><b>Purpose</b> To start the unit immediately for the purpose of testing, trial...etc, short timer can be used. maintenance of the unit.</p> <p><b>Short Timer Setting</b></p> <ol style="list-style-type: none"> <li>27 Press [⏻] button to turn the unit OFF.</li> <li>28 Set the operation mode on the remote control without sending the signal to the unit.</li> <li>29 Use the tip of the pencil to push the [CHECK] button and hold, "00" will show on display, then press [SET] button to make "00" disappear.</li> <li>30 Press [⏻] button to turn the unit ON.</li> <li>31 When short timer is activated, all setting on the remote operates immediately, besides, all indications on the signal receiving unit turns ON continuously for 3 seconds.</li> </ol>

Item	Operation flow and applicable data, etc.	Description																											
<b>17. External static pressure settings</b>	<p><b>There are 2 ways to set external static pressure setting.</b></p> <p>1) By DIP SW 501-1, -2 [FC [5D]=0000 (factory default) is necessary.] Set the external static pressure setting with the DIP SW501-1, -2 on the indoor unit P.C. board as shown in the table below.</p>  <p>At factory default, both SW501-1 and -2 are set at OFF position.</p> <p>2) By Wired remote controller In this model, external static pressure setting can be set with FC data setting by wired remote controller. By changing FC [5D] data, it is possible to set the external static pressure setting as shown in the table below.</p> <table border="1" data-bbox="368 936 1329 1144"> <thead> <tr> <th>FC[5D]</th> <th>External static pressure setting</th> </tr> </thead> <tbody> <tr> <td>0000 (factory default)</td> <td>depends on DIP SW501-1, -2</td> </tr> <tr> <td>0001</td> <td>10Pa</td> </tr> <tr> <td>0002</td> <td>20Pa</td> </tr> <tr> <td>0003</td> <td>35Pa</td> </tr> <tr> <td>0004</td> <td>45Pa</td> </tr> </tbody> </table> <p>If FC[5D] is set to not 0000, external static pressure setting does not follow the positions of DIP SW501-1,-2. At factory default, FC[5D] data is set to 0000.</p>	FC[5D]	External static pressure setting	0000 (factory default)	depends on DIP SW501-1, -2	0001	10Pa	0002	20Pa	0003	35Pa	0004	45Pa	<table border="1" data-bbox="903 365 1444 568"> <thead> <tr> <th>External static pressure</th> <th>SW501-2</th> <th>SW501-1</th> </tr> </thead> <tbody> <tr> <td>10 Pa (default)</td> <td>OFF</td> <td>OFF</td> </tr> <tr> <td>20 Pa</td> <td>OFF</td> <td>ON</td> </tr> <tr> <td>35 Pa</td> <td>ON</td> <td>OFF</td> </tr> <tr> <td>45 Pa</td> <td>ON</td> <td>ON</td> </tr> </tbody> </table>	External static pressure	SW501-2	SW501-1	10 Pa (default)	OFF	OFF	20 Pa	OFF	ON	35 Pa	ON	OFF	45 Pa	ON	ON
FC[5D]	External static pressure setting																												
0000 (factory default)	depends on DIP SW501-1, -2																												
0001	10Pa																												
0002	20Pa																												
0003	35Pa																												
0004	45Pa																												
External static pressure	SW501-2	SW501-1																											
10 Pa (default)	OFF	OFF																											
20 Pa	OFF	ON																											
35 Pa	ON	OFF																											
45 Pa	ON	ON																											

### 9-3. Auto Restart Function

This indoor unit is equipped with an automatic restarting function which allows the unit to restart operating with the set operating conditions in the event of a power supply being accidentally shut down. The operation will resume without warning three minutes after power is restored. This function is not set to work when shipped from the factory. Therefore it is necessary to set it to work.

#### 9-3-1. How to Set the Auto Restart Function

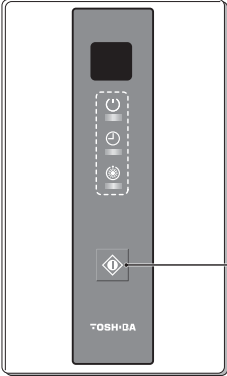
To set the auto restart function, proceed as follows:

The power supply to the unit must be on ; the function will not set if the power is off.

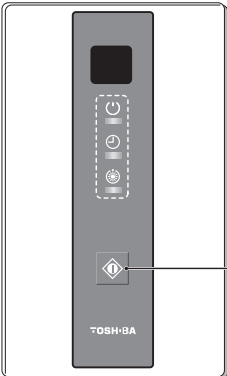
Press and hold the TEMPORARY button on the signal receiving unit for 3 seconds to set the operation (3 beep sound and OPERATION lamp blink 5 time/sec for 5 seconds).

The unit then restarts operating automatically in the event of power supply being accidentally shut down.

#### • When the unit is standby (Not operating)

Operation	Motions
<p>Press [TEMPORARY] button for more than three seconds. (Less than 10 seconds)</p> 	<p>The unit is on standby.</p> <p style="text-align: center;">↓</p> <p>The unit starts to operate.                      The green indicator is on.</p> <p style="text-align: center;">↓                      After approx. three seconds, release [TEMPORARY] button from being pushed.</p> <p>The unit beeps three times and continues to operate.                      <b>The green indicator flashes for 5 seconds.</b></p> <p>If the unit is not required to operate at this time, press [TEMPORARY] button once more or use the remote controller to turn it off.</p>

#### • When the unit is in operation

Operation	Motions
<p>Press [TEMPORARY] button for more than three seconds. (Less than 10 seconds)</p> 	<p>The unit is in operation.                      The green indicator is on.</p> <p style="text-align: center;">↓</p> <p>The unit stops operating.                      The green indicator is turned off.</p> <p style="text-align: center;">↓                      After approx. three seconds, release [TEMPORARY] button from being pushed.</p> <p>The unit beeps three times.                      <b>The green indicator flashes for 5 seconds.</b></p> <p>If the unit is required to operate at this time, press [TEMPORARY] button once more or use the remote controller to turn it on.</p>

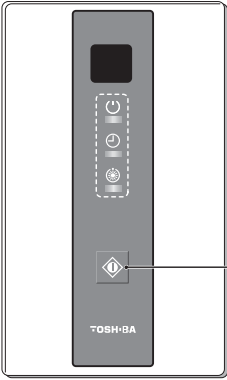
### 9-3-2. How to Cancel the Auto Restart Function

To cancel auto restart function, proceed as follows :

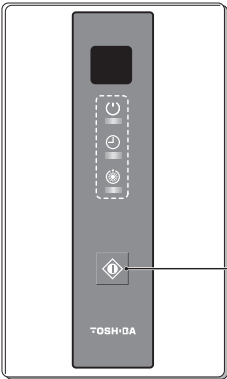
Repeat the setting procedure : the unit receives the signal and beeps three times.

The unit will be required to be turned on with the remote controller after the main power supply is turned off.

#### • When the system is on stand-by (not operating)

Operation	Motions
<p>Press [TEMPORARY] button for more than three seconds. (Less than 10 seconds)</p> 	<p>The unit is on standby.</p> <p style="text-align: center;">↓</p> <p>The unit starts to operate.                      The green indicator is on.</p> <p style="text-align: center;">↓</p> <p style="text-align: center;">After approx. three seconds, release [TEMPORARY] button from being pushed.</p> <p>The unit beeps three times and continues to operate.</p> <p>If the unit is not required to operate at this time, press [TEMPORARY] button once more or use the remote controller to turn it off.</p>

#### • When the system is operating

Operation	Motions
<p>Press [TEMPORARY] button for more than three seconds. (Less than 10 seconds)</p> 	<p>The unit is in operation.                      The green indicator is on.</p> <p style="text-align: center;">↓</p> <p>The unit stops operating.                      The green indicator is turned off.</p> <p style="text-align: center;">↓</p> <p style="text-align: center;">After approx. three seconds, release [TEMPORARY] button from being pushed.</p> <p>The unit beeps three times.</p> <p>If the unit is required to operate at this time, press [TEMPORARY] button once more or use the remote controller to turn it on.</p>

### 9-3-3. Power Failure During Timer Operation

When the unit is turned off because of power failure during timer operation, the timer operation is cancelled. In that case, set the timer operation again.

#### NOTE :

The Daily Timer is reset while a command signal can be received from the remote controller even if it stopped due to a power failure.

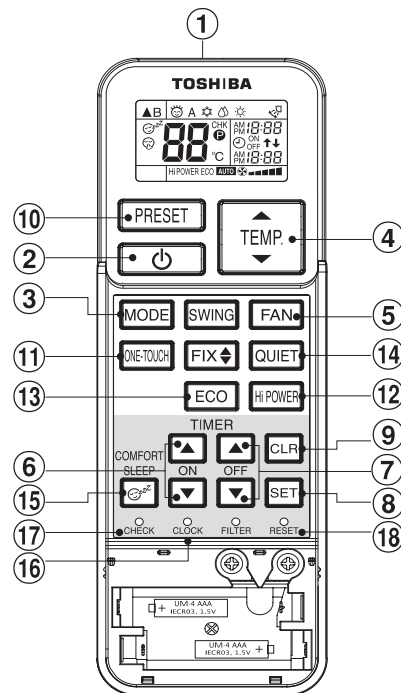
## 9-4. Remote control

### 9-4-1. Remote control and its functions

- ① Infrared signal emitter
- ② Start/Stop button
- ③ Mode select button (MODE)
- ④ Temperature button (TEMP)
- ⑤ Fan speed button (FAN)
- ⑥ On timer button (ON)
- ⑦ Off timer button (OFF)
- ⑧ Setup button (SET)
- ⑨ Clear button (CLR)
- ⑩ Memory and Preset button (PRESET)
- ⑪ One-Touch button (ONE-TOUCH)
- ⑫ High power button (Hi-POWER)
- ⑬ Economy button (ECO)
- ⑭ Quiet button (QUIET)
- ⑮ Comfort sleep button (COMFORT SLEEP)
- ⑯ Set clock button (CLOCK)
- ⑰ Check button (CHECK)
- ⑱ Reset button (RESET)

#### Note:

When pushing the “SWING”, “FIX” and “FILTER” buttons, indoor unit does not operate and the receiving beep sound also not appear.



### 9-4-2. Operation of remote control

#### 1. ONE-TOUCH

Press the “ONE-TOUCH” button for fully automated operation that is customized to the typical consumer preferences in your region of the world. The customized settings control temperature air flow strength, air flow direction and other settings to provide you alternate contact with “ONE-TOUCH” OF THE BUTTON. If you prefer other settings you can select from the many other operation functions of your Toshiba unit

Press : Start the operation.

#### 2. AUTOMATIC OPERATION

To automatically select cooling, or heating operation.

1. Press : Select A.
2. Press : Set the desired temperature.

#### 3. COOLING / HEATING OPERATION


To automatically select cooling, or heating operation.

1. Press : Select Cool , or Heat .
2. Press : Set the desired temperature.
3. Press : Select AUTO, LOW , LOW+ , MED , MED+ , or HIGH .



#### 4. DRY OPERATION (COOLING ONLY)

For dehumidification, a moderate cooling performance is controlled automatically.

1. Press **MODE** : Select Dry .
2. Press **TEMP.** : Set the desired temperature.

#### 5. Hi-POWER OPERATION

To automatically control room temperature and airflow for faster cooling or heating operation (except in DRY mode).

Press **Hi-POWER** : Start and stop the operation.

#### 6. ECO OPERATION

To automatically control room to save energy (except in DRY mode)

Press **ECO** : Start and stop the operation.

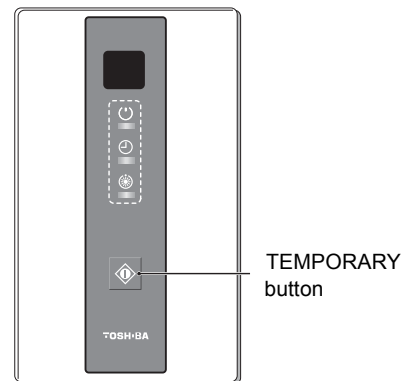
**Note:** Cooling operation; the set temperature will increase automatically 1 degree/hour for 2 hours (maximum 2 degrees increase).

For heating operation the set temperature will decrease.

#### 7. TEMPORARY OPERATION

In case of the misplaced or discharged remote control

- Pressing the TEMPORARY button, the unit can start or stop without using the remote control.
- Operation mode is set on AUTOMATIC operation, preset temperature is 24°C and fan operation is automatic speed.



#### 8. TIMER OPERATION

	Setting the ON Timer	Setting the OFF Timer
1	Press <b>ON</b> : Set the desired ON timer.	Press <b>OFF</b> : Set the desired OFF timer.
2	Press <b>SET</b> : Set the timer	Press <b>SET</b> : Set the timer.
3	Press <b>CLR</b> : Cancel the timer	Press <b>CLR</b>

Daily timer allows the user to set both the ON & OFF timers and will be activated on a daily basis.

##### Setting Daily Timer

1	Press <b>ON</b> : Set the ON timer.	3	Press <b>SET</b> .
2	Press <b>OFF</b> : Set the OFF timer.	4	Press <b>SET</b> : button during the (↑ or ↓) mark flashing.




- During the daily timer is activation, both arrows (↑ or ↓) are indicated.

##### Note:

- Keep the remote control in accessible transmission to the indoor unit; otherwise, the time lag of up to 15 minutes will occur.
- The setting will be saved for the next same operation.

## 9. PRESET OPERATION

Set your preferred operation for future use. The setting will be memorized by the unit for future operation (except air flow direction).

1. Select your preferred operation.
2. Press and hold  for 3 seconds to memorize the setting. The  mark displays.
3. Press  : Operate the preset operation.

## 10. AUTO RESTART OPERATION


To automatically restart the conditioner after the power failure (Power of the unit must be on.)

### Setting

1. Press and hold the TEMPORARY button on the signal receiving unit for 3 seconds to set the operation (3 beep sound and OPERATION lamp blink 5 time/sec for 5 seconds).
2. Press and hold the TEMPORARY button on the signal receiving unit for 3 seconds to cancel the operation (3 beep sound but OPERATION lamp does not blink).

## 11. QUIET OPERATION


To operate at super low fan speed for quiet operation (except in DRY mode)

Press  : Start and stop the operation.

**Note:** Under certain conditions, QUIET operation may not provide adequate cooling due to low sound features.

## 12. COMFORT SLEEP OPERATION



To save energy while sleeping, automatically control air flow and automatically turn OFF.

Press  : Select 1, 3, 5 or 9 hrs for OFF timer operation.

**Note:** The cooling operation, the set temperature will increase automatically 0.5 degree/hour for 4 hours (maximum 2 degrees increase).






## 13. SELF CLEANING OPERATION (COOL AND DRY OPERATION ONLY)

To protect bad smell caused by the humidity in the indoor unit.

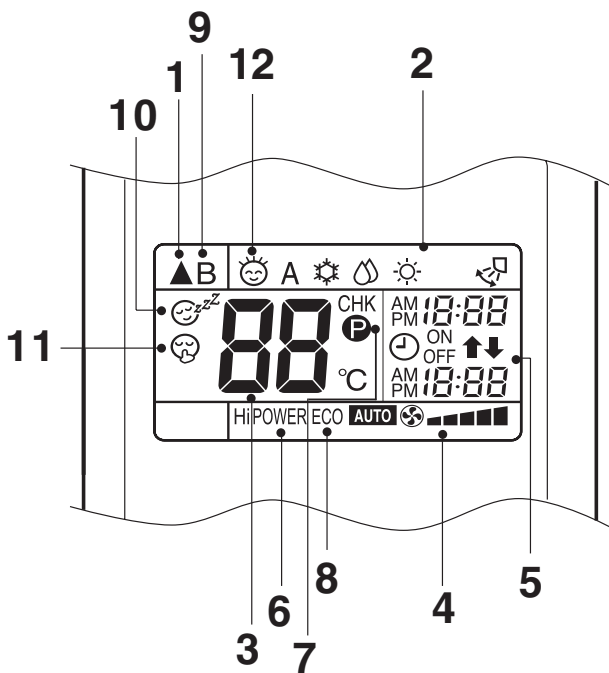
1. If the  button is pressed once during "Cool" or "Dry" mode, the fan will continue to run for other 30 minutes, then it will turn off automatically. This will reduce the moisture in the indoor unit.  
If the time of "Cool" or "Dry" operation is less than 10 minutes, the self cleaning operation is not performed.
2. To stop the unit immediately, press the  more 2 times within 30 seconds.

### 9-4-3. Name and Functions of Indications on Remote Controller [Display]

All indications, except for the clock time indicator, are displayed by pressing the  button.

- 1 Transmission mark**  
This transmission mark ▲ indicates when the remote controller transmits signals to the indoor unit.
- 2 Mode indicator**  
Indicates the current operation mode.  
(AUTO : Automatic control, A : Auto changeover control, ❄️ : Cool, 💧 : Dry, Heat ☀️)
- 3 Temperature indicator**  
Indicates the temperature setting.  
(17°C to 30°C)
- 4 FAN speed indicator**  
Indicates the selected fan speed.  
AUTO or five fan speed levels  
(LOW , LOW+ , MED , MED+ , HIGH ) can be shown.  
Indicates AUTO when the operating mode is either AUTO or 💧 : Dry.

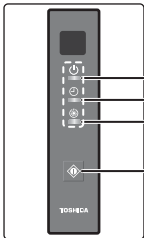
- 5 TIMER and clock time indicator**  
The time setting for timer operation or the clock time is indicated.  
The current time is always indicated except during TIMER operation.
- 6 Hi-POWER indicator**  
Indicates when the Hi-POWER operation starts.  
Press the Hi-POWER button to start and press it again to stop the operation.
- 7 (P) (PRESET) indicator**  
Flashes for 3 seconds when the PRESET button is pressed during operation.  
The (P) mark is shown when holding down the button for more than 3 seconds while the mark is flashing.  
Press another button to turn off the mark.
- 8 ECO indicator**  
Indicates when the ECO is in activated.  
Press the ECO button to start and press it again to stop operation.
- 9 A, B change indicator remote controller**  
When the remote controller switching function is set, "B" appears in the remote controller display.  
(When the remote controller setting is "A", there is no indication at this position.)
- 10 Comfort sleep**  
Indicates when comfort sleep is activated.  
Press comfort sleep button to selector.
- 11 Quiet**  
Indicates when quiet is activated.  
Press quiet button to start and press it again to stop operation.
- 12 One-Touch**  
Indicates when one touch comfort is activated.  
Press one-touch button to start the operation.



# 10. OWNER'S MANUAL AND INSTALLATION MANUAL (EXCERPT)

## 10-1. Installation Diagram of Indoor OWNER'S MANUAL (EXCERPT)

### 1 SIGNAL RECEIVING UNIT DISPLAY



- ① OPERATION (Green)
- ② TIMER (Orange)
- ③ PRE.DEF (Preheat/Defrost/Self Cleaning) (Orange)
- ④ TEMPORARY button

### 2 PREPARATION BEFORE USE

#### Loading Batteries

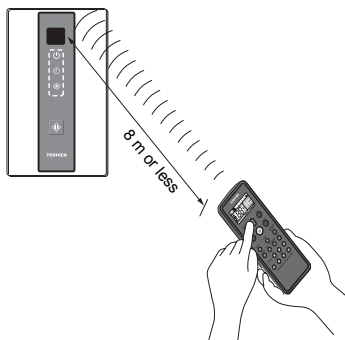
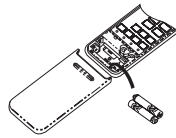
1. Remove the slide cover.
2. Insert 2 new batteries (AAA type) following the (+) and (-) positions.

#### Clock Setup

1. Push **CLOCK** by tip of the pencil. If timer indication is flashing, go to the next step 2.

2. Press **ON** or **OFF** to adjust the time.

3. Press **SET** to set the time.



#### Remote Control Reset

Push **RESET** by tip of the pencil or

1. Remove the batteries.
2. Press **ON**.
3. Insert the batteries.

#### Start/Stop

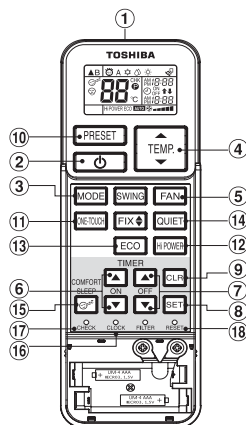
1. Press **ON** to start operation. (A receiving beep is heard)
2. Press **OFF** to stop operation. (A receiving beep is heard)

### 3 REMOTE CONTROL

- ① Infrared signal emitter
- ② Start/Stop button
- ③ Mode select button (MODE)
- ④ Temperature button (TEMP)
- ⑤ Fan speed button (FAN)
- ⑥ On timer button (ON)
- ⑦ Off timer button (OFF)
- ⑧ Setup button (SET)
- ⑨ Clear button (CLR)
- ⑩ Memory and Preset button (PRESET)
- ⑪ One-Touch button (ONE-TOUCH)
- ⑫ High power button (HI-POWER)
- ⑬ Economy button (ECO)
- ⑭ Quiet button (QUIET)
- ⑮ Comfort sleep button (COMFORT SLEEP)
- ⑯ Set clock button (CLOCK)
- ⑰ Check button (CHECK)
- ⑱ Reset button (RESET)

#### Note:

When pushing the "SWING", "FIX" and "FILTER" buttons, indoor unit does not operate and the receiving beep sound also not appear.



### 4 ONE-TOUCH

Press the "ONE-TOUCH" button for fully automated operation that is customized to the typical consumer preferences in your region of the world. The customized settings control temperature, air flow strength and other settings to provide you alternate contact with "ONE-TOUCH" of the button. If you prefer other settings you can select from the many other operating functions of your Toshiba unit.

Press **ONE-TOUCH** : Start the operation.

### 5 AUTOMATIC OPERATION

To automatically select cooling or heating operation

1. Press **MODE** : Select A.
2. Press **TEMP** : Set the desired temperature.
3. Press **FAN** : Select AUTO, LOW, LOW+, MED, MED+, or HIGH.

### 6 COOLING / HEATING OPERATION

1. Press **MODE** : Select Cool or Heat.
2. Press **TEMP** : Set the desired temperature.
3. Press **FAN** : Select AUTO, LOW, LOW+, MED, MED+, or HIGH.

### 7 DRY OPERATION

For dehumidification, a moderate cooling performance is controlled automatically.

1. Press **MODE** : Select Dry.
2. Press **TEMP** : Set the desired temperature.

### 8 Hi-POWER OPERATION

To automatically control room temperature and cooling (or heating) capacity for faster cooling (or heating) operation. (except in DRY mode)

Press **HI-POWER** : Start and stop the operation.

### 9 ECO OPERATION

To automatically control room to save energy (except in DRY mode)

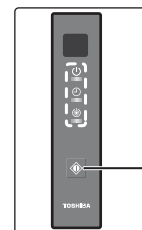
Press **ECO** : Start and stop the operation.

**Note:** Cooling operation; the set temperature will increase automatically 1 degree/hour for 2 hours (maximum 2 degrees increase). For heating operation the set temperature will decrease.

### 10 TEMPORARY OPERATION

In case of the misplaced or discharged remote control

- Pressing the TEMPORARY button, the unit can start or stop without using the remote control.
- Operation mode is set on AUTOMATIC operation, preset temperature is 24°C and fan operation is automatic speed.



### 11 TIMER OPERATION

Set the timer when the air conditioner is operating.

	Setting the ON Timer	Setting the OFF Timer
1	Press <b>ON</b> : Set the desired ON timer.	Press <b>OFF</b> : Set the desired OFF timer.
2	Press <b>SET</b> : Set the timer.	Press <b>SET</b> : Set the timer.
3	Press <b>CLR</b> : Cancel the timer.	Press <b>CLR</b> : Cancel the timer.

Daily timer allows the user to set both the ON & OFF timers and will be activated on a daily basis.

### Setting Everyday Timer

1	Press  : Set the ON timer.	3	Press  .
2	Press  : Set the OFF timer.	4	Press  button during the (↑ or ↓) mark flashing.

- During the every day timer is activating, both arrows (↑, ↓) are indicated.

#### Note:

- Keep the remote control in accessible transmission to the signal receiving unit; otherwise, the time lag of up to 15 minutes will occur.
- The setting will be saved for the next same operation.

## 12 PRESET OPERATION

Set your preferred operation for future use. The setting will be memorized by the unit for future operation.

1. Select your preferred operation.
2. Press and hold for 3 seconds to memorize the setting. The **P** mark displays.
3. Press : Operate the preset operation.

## 13 AUTO RESTART OPERATION

To automatically restart the air conditioner after the power failure (Power of the unit must be on.)

#### Setting

1. Press and hold the TEMPORARY button on the signal receiving unit for 3 seconds to set the operation. (3 beep sound and OPERATION lamp blink 5 time/sec for 5 seconds)
2. Press and hold the TEMPORARY button on the signal receiving unit for 3 seconds to cancel the operation. (3 beep sound but OPERATION lamp does not blink)

## 14 QUIET OPERATION

To operate at super low fan speed for quiet operation (except in DRY mode)

Press : Start and stop the operation.

**Note:** Under certain conditions, QUIET operation may not provide adequate cooling due to low sound features.

## 15 COMFORT SLEEP OPERATION

For comfortable sleep, automatically control air flow and automatically turn OFF.

Press : Select 1, 3, 5 or 9 hrs for OFF timer operation.

**Note:** The cooling operation, the set temperature will increase automatically 1 degree/hour for 2 hours (maximum 2 degrees increase). For heating operation, the set temperature will decrease.

## 16 SELF CLEANING OPERATION (COOL AND DRY OPERATION ONLY)

To protect bad smell caused by the humidity in the indoor unit.

1. If the button is pressed once during "Cool" or "Dry" mode, the fan will continue to run for other 30 minutes, then it will turn off automatically. This will reduce the moisture in the indoor unit.  
If the time of "Cool" or "Dry" operation is less than 10 minutes, the self cleaning operation is not performed.
2. To stop the unit immediately, press the more 2 times within 30 seconds.

## 17 OPERATION AND PERFORMANCE

1. Three-minute protection feature: To prevent the unit from being activated for 3 minutes when suddenly restarted or switched to ON.
2. Preheating operation: Warm up the unit for 5 minutes before blowing warm air.
3. Warm air control: When the room temperature reaches the set temperature, the fan speed is automatically reduced and the outdoor unit will stop.
4. Automatic defrosting: Fans will stop during defrost operation.
5. Heating capacity: Heat is absorbed from outdoor and released into the room. When the outdoor temperature is too low, use another recommended heating apparatus in combination with the air conditioner.
6. Consideration for accumulated snow: Select the position for outdoor unit where it will not be subjected to snow drifts, accumulation of leaves or other seasonal debris.

### Air conditioner operating conditions

Operation	Temp.	Outdoor Temperature	Room Temperature
Heating		※	Less than 28°C
Cooling		※	21°C ~ 32°C
Dry		※	17°C ~ 32°C

※ Refer to the Installation Manual of the outdoor unit.

## 18 TROUBLESHOOTING (CHECK POINT)

The unit does not operate.	Cooling or Heating is abnormally low.
<ul style="list-style-type: none"> <li>• The power main switch is turned off.</li> <li>• The circuit breaker is activated to cut off the power supply.</li> <li>• Stoppage of electric current</li> <li>• ON timer is set.</li> </ul>	<ul style="list-style-type: none"> <li>• The air filter (Locally procured) is blocked with dust.</li> <li>• The temperature has been set improperly.</li> <li>• The windows or doors are opened.</li> <li>• The air inlet or outlet of the outdoor unit is blocked.</li> <li>• The fan speed is too low.</li> <li>• The operation mode is DRY.</li> </ul>

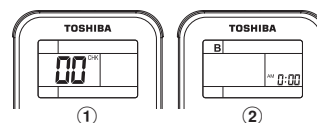
## 19 REMOTE CONTROL A-B SELECTION

To separate using of remote control for each indoor unit in case of 2 air conditioners are installed nearby.

#### Remote Control B Setup.


















1. Press TEMPORARY button on the signal receiving unit to turn the air conditioner ON.
2. Point the remote control at the signal receiving unit.
3. Push and hold button on the Remote Control by the tip of the pencil. "00" will be shown on the display.
4. Press during pushing . "B" will show on the display and "00" will disappear and the air conditioner will turn OFF. The Remote Control B is memorized.

**Note:** 1. Repeat above step to reset Remote Control to be A.  
2. Remote Control A has not "A" display.  
3. Default setting of Remote Control from factory is A.



## 10-2. Accessory parts

### INSTALLATION MANUAL (EXCERPT)

Part name	Q'ty	Shape	Usage
Installation Manual	1	This manual	(Be sure to hand over to customers)
Insulating pipe	2		For insulating pipe connecting section
Washer	8	M10 × Ø34	For hanging down the unit
Hose band	1		For connecting drain pipe
Flexible hose	1		For adjustment of drain pipe centering
Heat insulator	1		For insulating drain connecting section
Signal receiving unit	1		
Mounting bracket	1		For signal receiving unit
Screw	2	 M4 x 25 mm	For signal receiving unit
Screw	2	 M4 x 40 mm	For signal receiving unit
Wood Screw	2	 Ø3.8 x 16 mm	For signal receiving unit
Spacer	4		For signal receiving unit
Pattern template	1	 95 mm x 51 mm	For signal receiving unit
Remote controller	1		
Battery	2		
Remote controller holder	1		For remote controller
Screw	2	 Ø3.1 x 16 mm	For remote controller holder
Owner's Manual	1		
CD-ROM	1		For some models only

## 10-3. Selection of installation place

### Avoid installing in the following places

Select a location for the indoor unit where the cool or warm air will circulate evenly.

Avoid installation in the following kinds of locations.

- Saline area (coastal area)
- Locations with acidic or alkaline atmospheres (such as areas with hot springs, factories where chemicals or pharmaceuticals are made and places where the exhaust air from combustion appliances will be sucked into the unit).  
Doing so may cause the heat exchanger (its aluminum fins and copper pipes) and other parts to become corroded.
- Locations with atmospheres with mist of cutting oil or other types of machine oil.  
Doing so may cause the heat exchanger to become corroded, mists caused by the blockage of the heat exchanger to be generated, the plastic parts to be damaged, the heat insulators to peel off, and other such problems to result.
- Locations where vapors from food oils are formed (such as kitchens where food oils are used).  
Blocked filters may cause the air conditioner's performance to deteriorate, condensation to form, the plastic parts to be damaged, and other such problems to result.
- Places where iron or other metal dust is present. If iron or other metal dust adheres to or collects on the interior of the air conditioner, it may spontaneously combust and start a fire.
- Locations near obstructions such as ventilation openings or lighting fixtures where the flow of the blown air will be disrupted (a disruption of the air flow may cause the air conditioner's performance to deteriorate or the unit to shut down).
- Locations where an in-house power generator is used for the power supply.  
The power line frequency and voltage may fluctuate, and the air conditioner may not work properly as a result.
- On truck cranes, ships or other moving conveyances.
- The air conditioner must not be used for special applications (such as for storing food, plants, precision instruments or art works).  
(The quality of the items stored may be degraded.)
- Locations where high frequencies are generated (by inverter equipment, in-house power generators, medical equipment or communication equipment).  
(Malfunctioning or control trouble in the air conditioner or noise may adversely affect the equipment's operation.)
- Locations where there is anything under the unit installed that would be exposed to wet risk.  
(If the drain has become blocked or when the humidity is over 80 %, condensation from the indoor unit will drip, possibly causing damage to anything underneath.)
- In the case of the wireless type of system, rooms with the inverter type of fluorescent lighting or locations exposed to direct sunlight.  
(The signals from the wireless remote controller may not be sensed.)
- Locations where organic solvents are being used.
- The air conditioner cannot be used for liquefied carbonic acid cooling or in chemical plants.
- Location near doors or windows where the air conditioner may come into contact with high-temperature, high-humidity outdoor air.  
(Condensation may occur as a result.)
- Locations where special sprays are used frequently.

## ■ Installation under high-humidity atmosphere

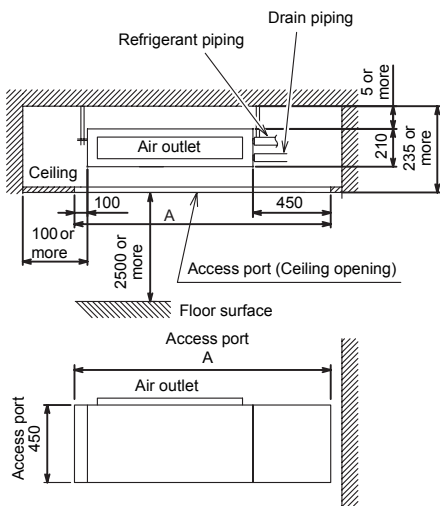
In some cases including the rainy season, especially inside of the ceiling may become high-humidity atmosphere (dew-point temperature: 23 °C or higher).

1. Installation to inside of the ceiling with tiles on the roof
2. Installation to inside of the ceiling with slated roof
3. Installation to a place where inside of the ceiling is used for pathway to intake the fresh air
4. Installation to a kitchen

- In the above cases, additionally attach the heat insulator to all positions of the air conditioner, which come to contact with the high-humidity atmosphere.
- Apply also a sufficient heat insulation to the duct and connecting part of the duct.

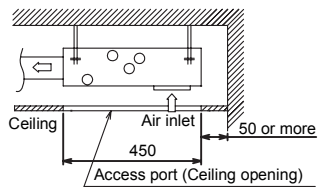
<b>[Reference]</b>	Condensation test conditions	Indoor side:	27 °C dry bulb temperature
			24 °C wet bulb temperature
	Air volume:	Low air volume, operation time 4 hours	

## ■ Installation space

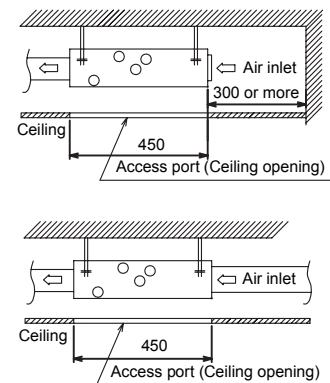


Model type	A
07, 10, 13 type	1,250
16 type	1,450
22, 24 type	1,650

### <Under air intake>



### <Back air intake>





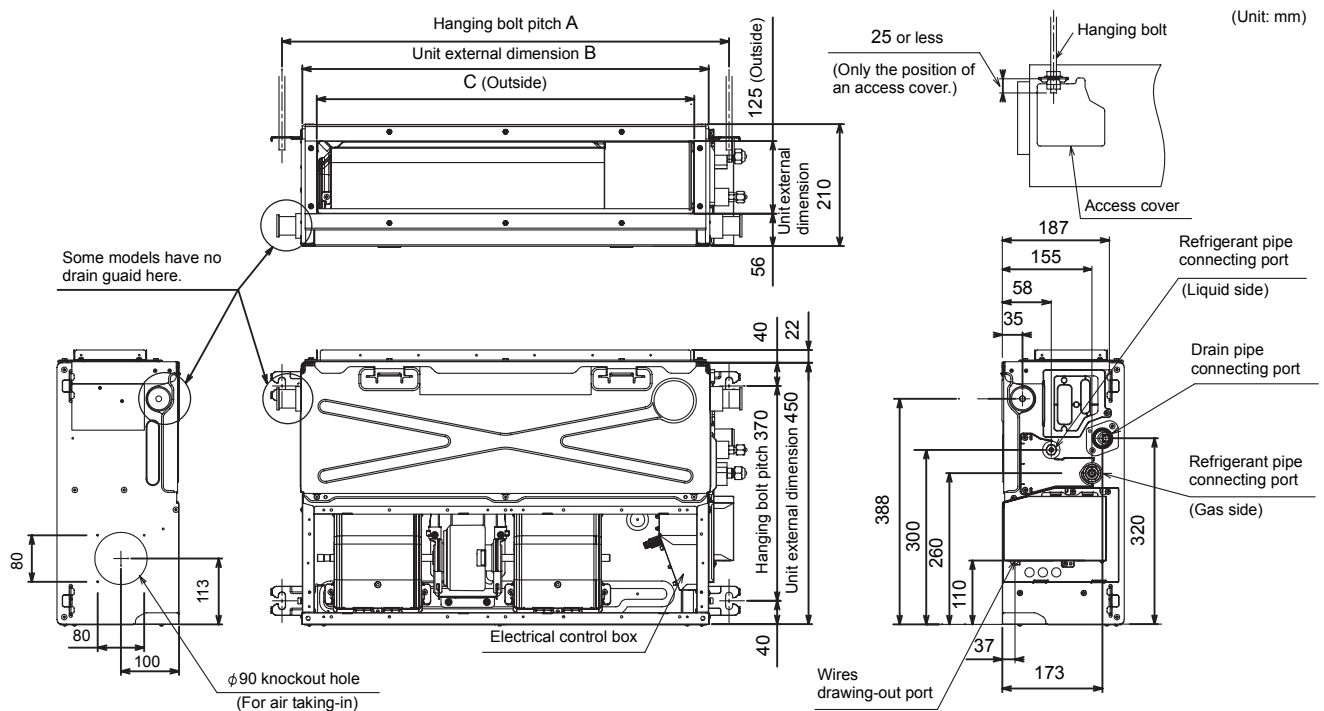
## 10-4. Installation

### ⚠ CAUTION

Strictly comply with the following rules to prevent damage of the indoor units and human injury.

- Do not put a heavy article on the indoor unit or let a person get on it. (Even units are packaged)
- Carry in the indoor unit as it is packaged if possible. If carrying in the indoor unit unpacked by necessity, use buffering cloth or other material not to damage the unit.
- To move the indoor unit, hold the hooking brackets (4 positions) only.
- Do not apply force to the other parts (refrigerant pipe, drain pan, foamed parts, resin parts or other parts).
- Hanging bolt pitch of air intake chamber side is different (centre position), make sure not to make mistake to install the setting direction.
- Carry the package by two or more persons, and do not bundle it with plastic band at positions other than specified.
- To install vibration isolation material to hanging bolts, confirm that it does not increase the unit vibration.

### ■ External dimensions



Model type	A	B	C
07,10,13 type	770	700	650
16 type	970	900	850
22,24 type	1,170	1,100	1,050

## ■ Installation of hanging bolt

- Consider the piping / wiring after the unit is hung to determine the location of the indoor unit installation and orientation.
- After the location of the indoor unit installation has been determined, install hanging bolts.
- For the dimensions of the hanging bolt pitches, refer to the external view.
- When a ceiling already exists, lay the drain pipe, refrigerant pipe, control wires, and remote controller wires to their connection locations before hanging the indoor unit.

Procure hanging bolts washer and nuts for installing the indoor unit (these are not supplied).

Hanging bolt	M10 or W3/8	4 pieces
Nut	M10 or W3/8	12 pieces
Washer	M10	8 pieces

### Installation of hanging bolt

Use M10 hanging bolts (4 pcs, locally procured).

Matching to the existing structure, set pitch according to size in the unit external view as shown below.

<p><b>New concrete slab</b></p> <p>Install the bolts with insert brackets or anchor bolts.</p> <p>(Blade type bracket)    (Slide type bracket)    (Pipe hanging anchor bolt)</p>
<p><b>Steel frame structure</b></p> <p>Use existing angles or install new support angles.</p> <p>Hanging bolt Support angle</p>
<p><b>Existing concrete slab</b></p> <p>Use a hole-in anchors, hole-in plugs, or a hole-in bolts.</p>

## ■ Installation of indoor unit

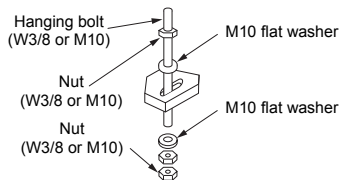
### Treatment of ceiling

The ceiling differs according to structure of building.

For details, consult your constructor or interior finish contractor.

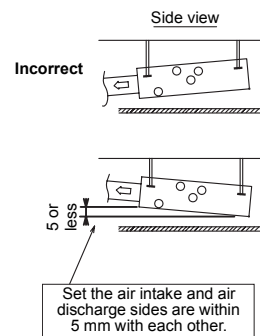
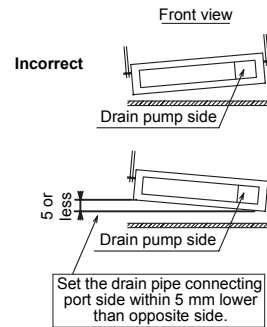
In the process after the ceiling board has been removed, it is important to reinforce ceiling foundation (frame) and to keep horizontal level of installed ceiling correctly in order to prevent vibration of ceiling board.

- Attach the nuts and the M10 flat washers to the hanging bolt.
- Put washers at up and down of the hanging bracket of the indoor unit to hang down the indoor unit.
- Check that four sides are horizontal with a level gauge. (Horizontal degree: Within 5 mm)



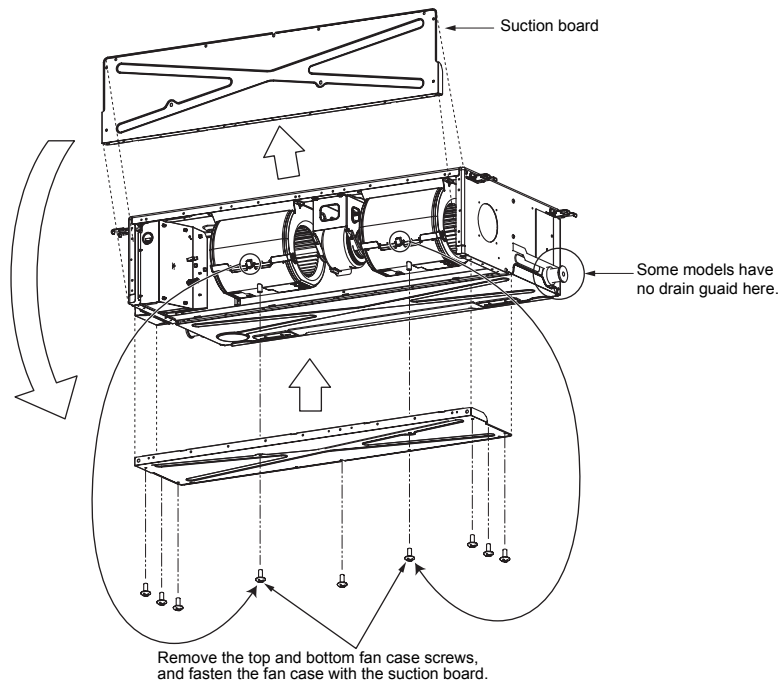
## REQUIREMENT

- Hang the unit in a horizontal position.  
When unit is hanged to slant, it may cause overflow of drainage.
- Install the unit within the dimension according to the figure below.
- Use level gauge to confirm whether the unit is hang horizontally.



## ■ Changing from under air intake to back air intake

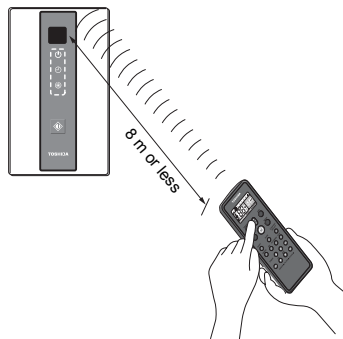
Remove the suction board cover attached to the back, and screw it to the bottom of unit.



## ■ Installation location of receiving unit

The sensor of indoor unit with wireless remote controller can receive a signal by distance within approx. 8 m. Based upon it, determine a place where the remote controller is operated and the installation place.

- Operate the remote controller, confirm that the indoor unit receives a signal surely, and then install it.
- Keep 1 m or more from the devices such as television, stereo.  
(Disturbance of image or noise may generate.)
- To prevent a malfunction, select a place where is not influenced by a fluorescent light or direct sunlight.



### How to Install the Signal Receiving Unit

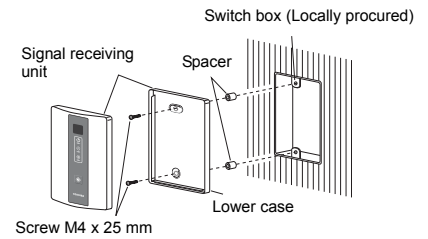
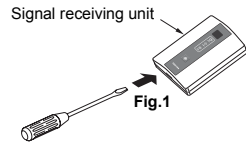
To prevent electric shocks, embed the wires in the wall and do not expose them. When installing wires on the wall, be sure to cover them with insulating materials.

#### Note:

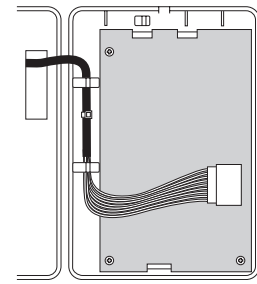
- To avoid malfunction of the remote controller, do not assemble or run remote control wiring together with the power cables, and do not enclose them in the same metal conduit.
- When the power unit induces electrical noise, it is recommended that a noise filter or the like be installed.

#### Installing into the switch box

1. Insert a flathead screwdriver or similar tool into the groove, and remove the lower case. (Fig. 1)
2. Fix the lower case with M4 x 25 mm screws provided. Do not overly tighten, and use the provided spacers. If the Signal receiving unit does not fit in the wall, cut spacers to adjust the clearance.

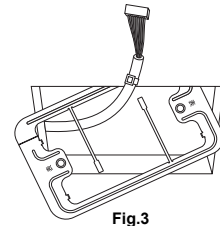


3. Connect the housing of Signal receiving unit with the connector of wires extended from the indoor unit. (Fig. 2)
4. Reattach the upper case.

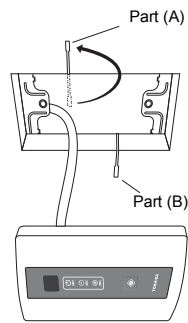


#### Mounting on the ceiling

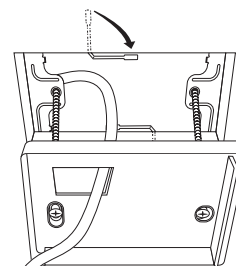
1. Cut a section out of the ceiling along the provided paper pattern (95 x 51 mm).
2. Pass the wire through the provided mounting bracket and insert the bracket into the installation hole. (Fig. 3)



3. Use bracket parts (A) and (B) to securely grip the ceiling material. (Fig. 4)
4. Connect the housing of Signal receiving unit with the connector of wires extended from the indoor unit.
5. Insert a slotted screwdriver into the opening at the bottom of the remote controller. Remove the lower case from the signal receiving unit.
6. Adjust the provided spacers so that they are several millimeters larger than the thickness of the ceiling material. Pass the 2 supplied screws (M4 x 40 mm) through the spacers and tighten them enough to hold the Signal receiving unit in place.



7. Return parts (A) and (B) through the gap between the ceiling and Signal receiving unit so that they are contained in the openings. Then tighten the screws. Do not tighten the screws excessively. This may result in damage or deformation of the case. Tighten to the point where the Signal receiving unit can be moved slightly by hand. (Fig. 5)
8. Firmly attach the signal receiving unit to the lower case.

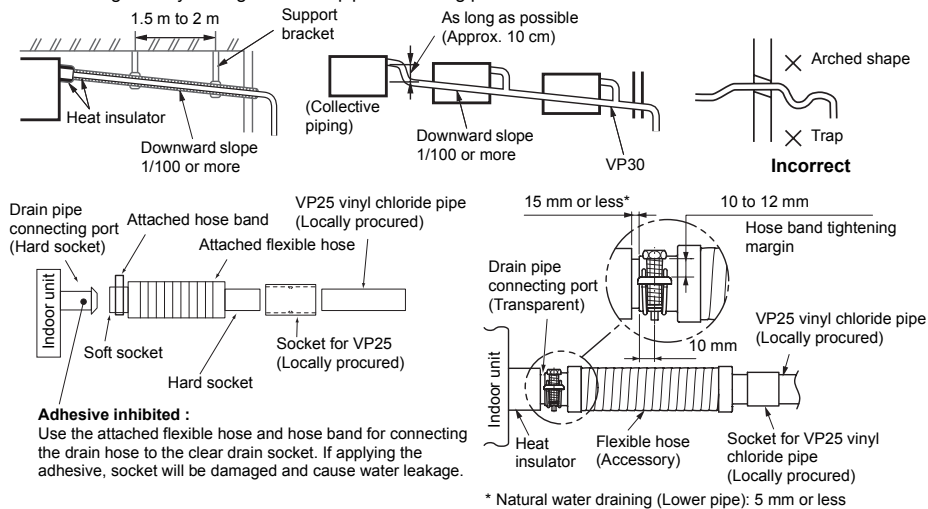


## 10-5. Drain piping

### ⚠ CAUTION

**Following the Installation Manual, perform the drain piping work so that water is properly drained. Apply a heat insulation so as not to cause a dew condensation. Inappropriate piping work may result in water leakage in the room and wet furniture.**

- Provide the indoor drain piping with proper heat insulation.
- Provide the area where the pipe connects to the indoor unit with proper heat insulation. Improper heat insulation will cause condensation to form.
- The drain pipe must be sloping downward (at an angle of 1/100 or more), and do not run the pipe up and down (arched shape) or allow it to form traps. Doing so may cause abnormal sounds.
- Restrict the length of the traversing drain pipe to 20 meters or less. For a long pipe, provide support brackets at intervals of 1.5 to 2 meters to prevent flapping.
- Install the collective piping as shown in the following figure.
- Do not provide any air vents. Otherwise, the drain water will spout, causing water to leak.
- Do not allow any force to be applied to the connection area with the drain pipe.
- A hard PVC pipe cannot be connected to the drain pipe connecting port of the indoor unit. Be absolutely sure to use the flexible hose provided for the connections with the drain pipe connecting port.
- Adhesive agents cannot be used for the drain pipe connecting port (hard socket) of the indoor unit. Be absolutely sure to secure the pipe using the hose bands provided. Use of an adhesive agent may damage the drain pipe connecting port or cause water to leak.



### ■ Pipe material, size and insulator

The following materials for piping work and insulating process are procured locally.

Pipe material	Hard vinyl chloride pipe VP25 (Nominal outer diameter Ø32 mm)
Insulator	Foamed polyethylene foam, thickness: 10 mm or more

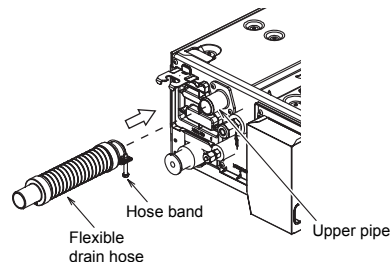
### ■ Connection of drain hose

- Connect a hard socket (locally procured) to the hard socket of the attached supplied flexible hose.
- Connect a drain pipe (locally procured) to the connected hard socket.

### REQUIREMENT

- Connect hard vinyl chloride pipes securely using an adhesive for vinyl chloride to avoid water leakage.
- It takes some time until the adhesive is dried and hardened (refer to the manual of the adhesive). Do not apply stress to the joint with the drain pipe during this time period.

Insert the flexible drain hose into the upper drain pipe and fix it with the hose band.

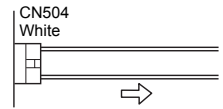


### Gravitational drainage

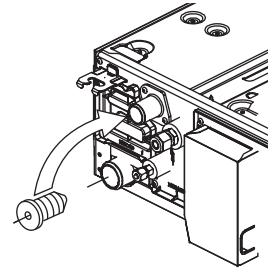
Gravitational drainage can be changed to natural water draining for models with a drain pump by following the steps below.

# 1 Remove the drain pump connector CN504.

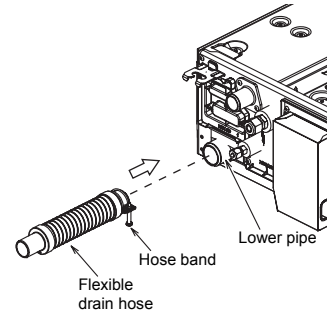
\* For gravitational drainage, remove the white connector (CN504) on the P.C. board in the electrical control box.



# 2 Move the plug to the upper pipe from the lower pipe on the side that will be used.



# 3 Insert the flexible drain hose into the lower drain pipe and fix it with the hose band.

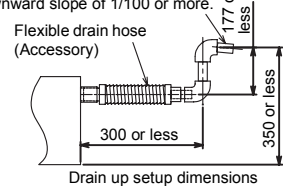


## ■ Drain up

When a down-gradient cannot be secured for the drain pipe, drain-up piping is possible.

- The height of the drain pipe must be 350 mm or less from the underside of the indoor unit.
- Take the drain pipe out of the drain pipe joint with the indoor unit in 300 mm or less, and bend up the pipe vertically.
- Immediately after the pipe is bent up vertically, lay the pipe making a down-gradient.

For drain pipes that will be connected after setup, make a downward slope of 1/100 or more.



## ■ Check the draining

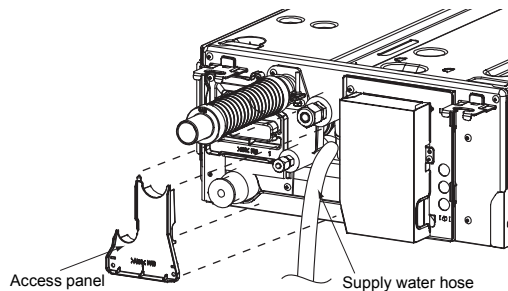
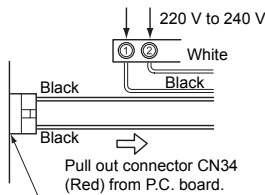
In the test run, check that water drain is properly performed and water does not leak from the connecting part of the pipes. When doing this, also check that no abnormal sounds are heard from the drain pump motor. Check draining also when installed in heating period.

### When the electrical and wiring work has been completed

Pour some water by following the method shown in the following figure. Then, while performing a cooling operation, check that the water drains from the drain pipe connecting port (transparent) and that no water is leaking from the drain pipe.

### When the electrical and wiring work has not been completed

- Disconnect the float switch connector (3P: red) from the connector (CN34: red) on the P.C. board inside the electrical control box. (Before doing this, the power must be turned off.)
- Connect a 220 V to 240 V supply voltage to (1) and (2) on the power supply terminal block. (Do not apply a 220 V to 240 V voltage to (A), (B) of the terminal block. Otherwise, the printed circuit board may be damaged.)
- Pour the water by following the method shown in the following figure. (Amount of water poured: 1500 cc to 2000 cc)
- When the power is turned on, the drain pump automatically starts running. Check whether the water is draining from the drain pipe connecting port, and check that no water is leaking from the drain pipe.
- After checking that the water drains and there are no water leaks, turn off the power, connect the float switch connector to its original location (CN34) on the P.C. board, and return the electrical control box to its original position.

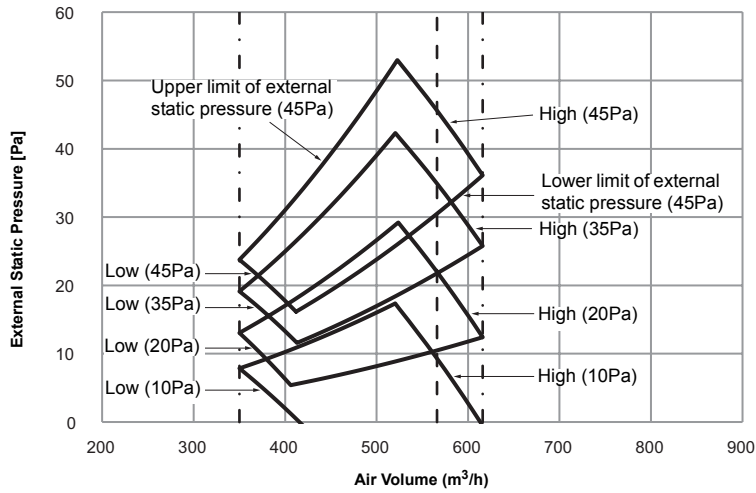




■ Fan characteristics

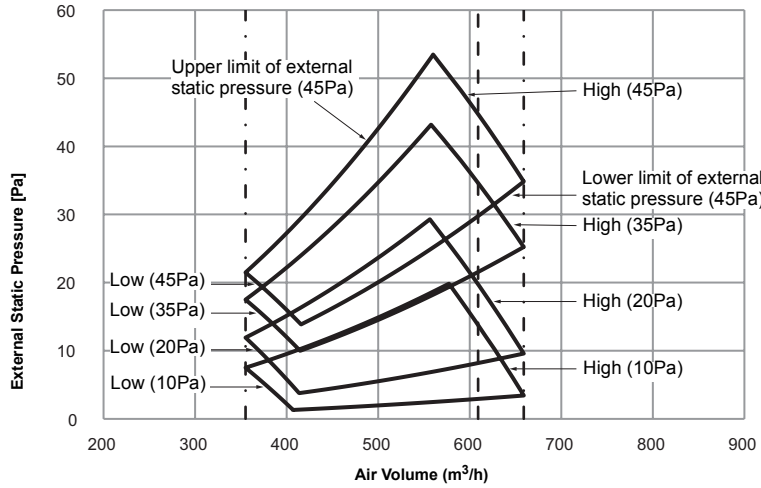
07,10 type

Standard Air Volume = 570m<sup>3</sup>/h



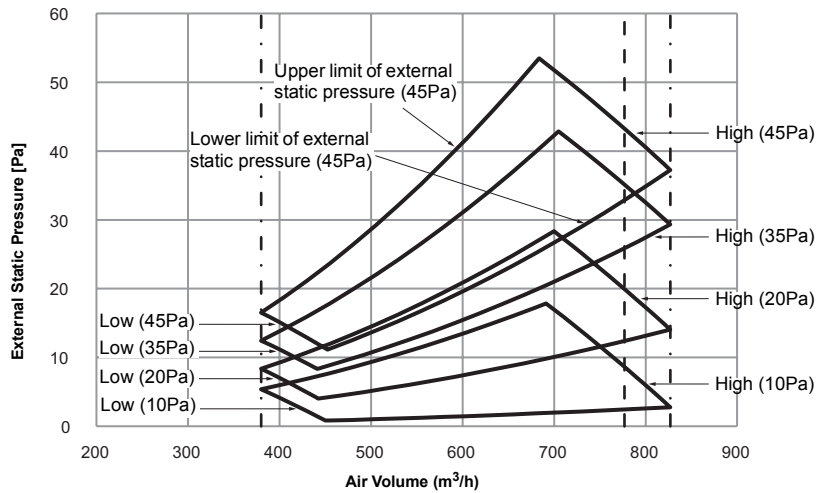
13 type

Standard Air Volume = 610m<sup>3</sup>/h



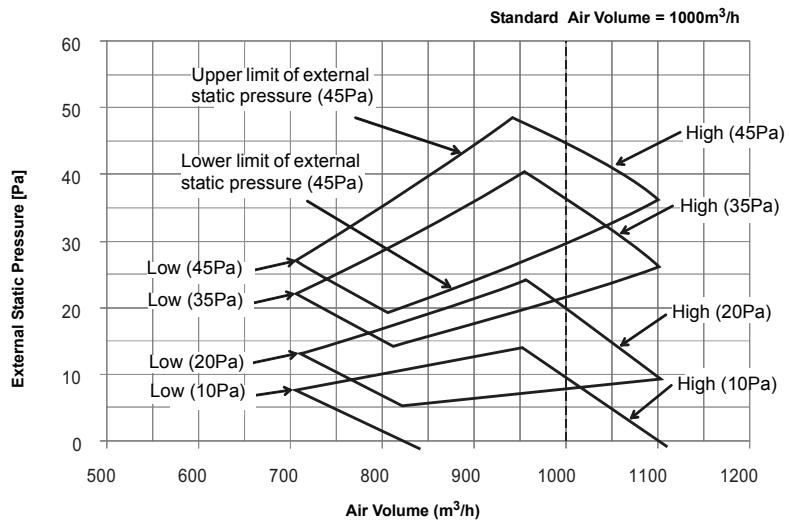
16 type

Standard Air Volume = 780m<sup>3</sup>/h

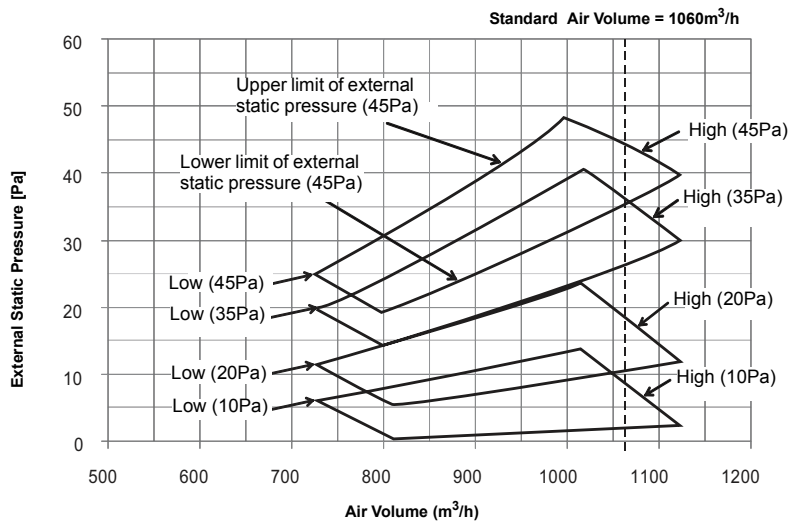




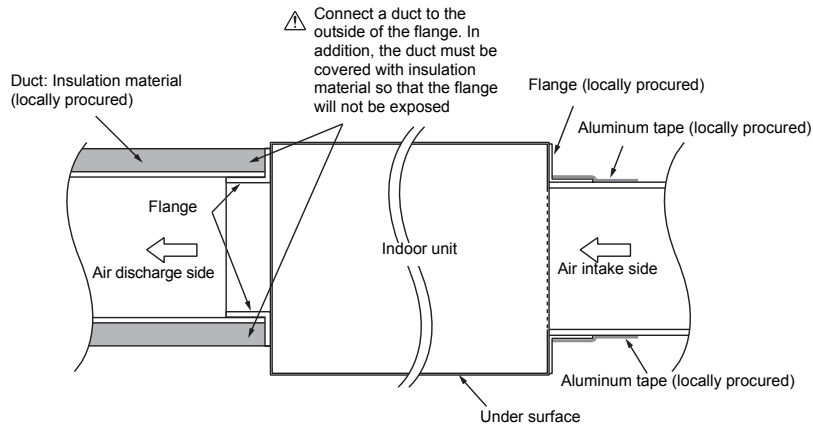
**22 type**



**24 type**



■ Connecting method of the duct



Attach the air intake grille and the air filter (locally procured) to the air intake side of ceiling opening

**⚠ CAUTION**

Incomplete heat insulation of the supply air flange and sealing may occur dewing resulted in falling of water drop.

## 10-7. Refrigerant piping

### ⚠ CAUTION

When the refrigerant pipe is long, provide support brackets at intervals of 2.5 to 3 m to clamp the refrigerant pipe. Otherwise, abnormal sound may be generated. Use the flare nut attached with the indoor unit or R32/R410A flare nut.

- Reusable mechanical connectors and flared joints are not allowed indoors. When mechanical connectors are reused indoors, sealing parts shall be renewed. When flared joints are reused indoors, the flare part shall be refabricated.

### ■ Permissible piping length and height difference

They vary depending on the outdoor unit. For details, refer to the Installation Manual attached to the outdoor unit.

### ■ Pipe size

Model RAS-	Pipe size (mm)	
	Gas side	Liquid side
M07,10,13	Ø9.5	Ø6.4
M16	Ø12.7	Ø6.4
M22,24	Ø12.7	Ø6.4

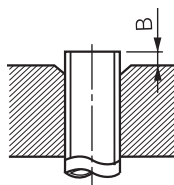
### ■ Connecting refrigerant piping

#### Flaring

1. Cut the pipe by a pipe cutter.  
Remove burrs completely. (Remaining burrs may cause gas leakage.)
2. Insert a flare nut into the pipe, and flare the pipe. Use the flare nut provided with the unit or the one used for the R32/R410A refrigerant. The flaring dimensions for R32/R410A are different from the ones used for the conventional R22 refrigerant. A new flare tool manufactured for use with the R32/R410A refrigerant is recommended, but the conventional tool can still be used if the projection margin of the copper pipe is adjusted to be as shown in the following table.

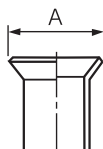
#### Projection margin in flaring: B (Unit: mm)

Outer dia. of copper pipe	R32 or R410A tool used	Conventional tool used
6.4, 9.5 12.7	0 to 0.5	1.0 to 1.5

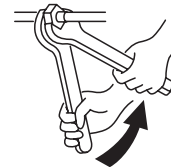


#### Flaring diameter size: A (Unit: mm)

Outer dia. of copper pipe	A <sup>①</sup>
6.4	9.1
9.5	13.2
12.7	16.6



- Do not scratch the inner surface of the flared part when removing burrs.
- Flare processing under the condition of scratches on the inner surface of flare processing part will cause refrigerant gas leak.
- Check that the flared part is not scratched, deformed, stepped, or flattened, and that there are no chips adhered or other problems, after flare processing.
- Do not apply refrigerating machine oil to the flare surface.
- The sealed gas was sealed at the atmospheric pressure so when the flare nut is removed, there will no "whooshing" sound: This is normal and is not indicative of trouble.
- Use two wrenches to connect the indoor unit pipe.



Work using double spanner

- Use the tightening torque levels as listed in the table below.

Outer dia. of connecting pipe (mm)	Tightening torque (N·m)
6.4	14 to 18 (1.4 to 1.8 kgf·m)
9.5	34 to 42 (3.4 to 4.2 kgf·m)
12.7	49 to 61 (4.9 to 6.1 kgf·m)

- Tightening torque of flare pipe connections.  
Using a torque wrench, tighten the flare pipe connecting sections which connect the indoor and outdoor units of the specified tightening torque. Incorrect connections may cause not only a gas leak, but also a trouble of the refrigeration cycle.

### ⚠ CAUTION

Tightening with an excessive torque may crack the nut depending on installation conditions.

### ■ Airtight test / Air purge, etc.

For air tightness test, vacuum drying and adding refrigerant, refer to the Installation Manual attached to the outdoor unit.

### ■ Open the valve fully

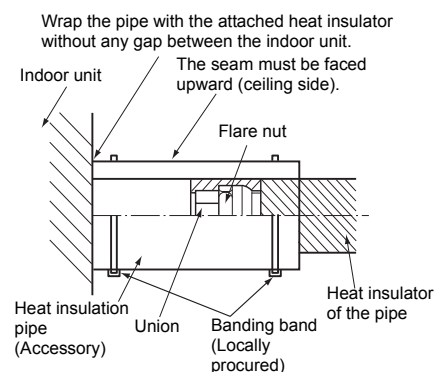
Open the valve of the outdoor unit fully.

### ■ Heat insulation process

- Apply heat insulation for the pipes separately at liquid side and gas side.
- For the heat insulation to the pipes at gas side, use the material with heat-resisting temperature 120 °C or higher.
- To use the attached heat insulation pipe, apply the heat insulation to the pipe connecting section of the indoor unit securely without gap.

#### REQUIREMENT

- Apply the heat insulation to the pipe connecting section of the indoor unit securely up to the root without exposure of the pipe. (The pipe exposed to the outside causes water leak.)
- Wrap heat insulator with its slits facing up (ceiling side).



## 10-8. Electrical connection

1. The supply voltage must be the same as the rated voltage of the air conditioner.
2. Prepare the power source for exclusive use with the air conditioner.

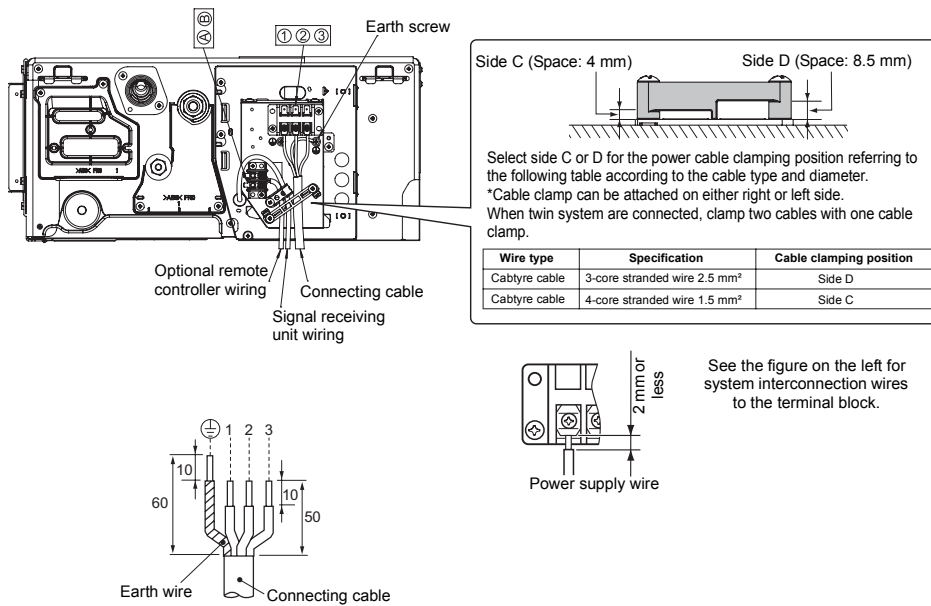
### NOTE

- Wire type : More than H07RN-F or 60245 IEC66 (1.5 mm<sup>2</sup> or more).

### REQUIREMENT

- Connect the wires matching the terminal numbers. Incorrect connection may cause a trouble.
- Keep a margin (Approx. 100 mm) on a wire to hang down the electrical control box at servicing or other purpose.

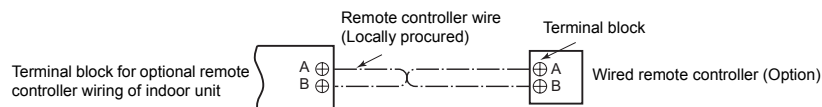
1. Before performing wiring work in the electrical control box, remove the cover of the box (fixed with 1 screw).
  2. Tighten the screws of the terminal block firmly, and fix the wires with the cord clamps attached to the electrical control box. (Do not apply tension to the connecting section of the terminal block.)
- Mount the cover of the electrical control box without pinching wires.



### ■ Optional wired remote controller wiring

Strip off approx. 9 mm the wire to be connected.

#### Wiring diagram



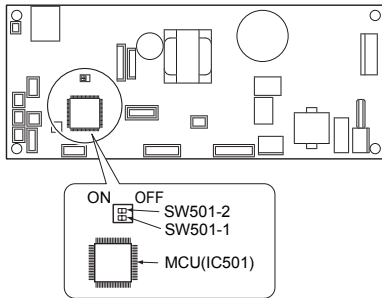
### NOTE

Even if the wireless remote controller of accessory parts connects with terminal block of indoor unit, it cannot be used.

## 10-9. Others

### External static pressure settings

Change the external static pressure setting with the DIP switch on the indoor unit P.C. board.



External static pressure	SW501-2	SW501-1
10 Pa (default)	OFF	OFF
20 Pa	OFF	ON
35 Pa	ON	OFF
45 Pa	ON	ON

### To restore the factory defaults

To return the DIP switch settings to the factory defaults, set SW501-1 and SW501-2 to OFF.

### Remote Control A-B Selection

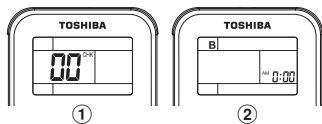
- When two indoor units are installed in the same room or adjacent two rooms, if operating a unit, two units may receive the remote control signal simultaneously and operate. In this case, the operation can be preserved by setting either one remote control to B setting. (Both are set to A setting in factory shipment.)
- The remote control signal is not received when the settings of indoor unit and remote control are different.
- There is no relation between A setting/B setting and A room/B room when connecting the piping and cables.

To separate using of remote control for each indoor unit in case of 2 air conditioners are installed near.

#### Remote Control B Setup.

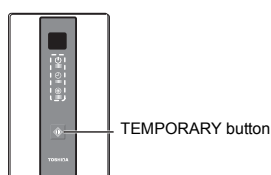
- Press TEMPORARY button on the signal receiving unit to turn the air conditioner ON.
- Point the remote control at the signal receiving unit.
- Push and hold  $\text{CHECK}$  button on the Remote Control by the tip of the pencil. "00" will be shown on the display.
- Press  $\text{MODE}$  during pushing  $\text{CHECK}$ . "B" will show on the display and "00" will disappear and the air conditioner will turn OFF. The Remote Control B is memorized.

- Note :
- Repeat above step to reset Remote Control to be A.
  - Remote Control A has not "A" display.
  - Default setting of Remote Control from factory is A.



### Test Operation

To switch to the TEST RUN (COOL) mode, press TEMPORARY button for 10 seconds. (The beeper will make a short beep.) In the TEST RUN (COOL) mode, all LEDs together keep blinking.



In order to prevent a serial operation, the TEST RUN (COOL) mode is released after 60 minutes have passed and returns to the usual operation.

### Auto Restart Setting

This product is designed so that, after a power failure, it can restart automatically in the same operating mode as before the power failure.

#### Information

The product was shipped with Auto Restart function in the off position. Turn it on as required.

#### How to set the Auto Restart

- Press and hold the TEMPORARY button on the signal receiving unit for 3 seconds to set the operation (3 beep sound and OPERATION lamp blink 5 time/sec for 5 seconds).
- Press and hold the TEMPORARY button on the signal receiving unit for 3 seconds to cancel the operation (3 beep sound but OPERATION lamp does not blink).

## 11. HOW TO DIAGNOSE THE TROUBLE

The pulse motor circuits are mounted to both indoor and outdoor units. Therefore, diagnose troubles according to the trouble diagnosis procedure as described below. (Refer to the check points in servicing written on the wiring diagrams attached to the indoor/outdoor units.)

Table 11-1

No.	Troubleshooting Procedure	No.	Troubleshooting Procedure
1	First Confirmation	6	How to Check Simply the Main Parts
2	Primary Judgment	7	Troubleshooting
3	Judgment by Flashing LED of the signal receiving unit	8	How to Diagnose Trouble in Outdoor Unit
4	Self-Diagnosis by Remote Controller	9	How to Check Simply the Main Parts
5	Judgment of Trouble by Every Symptom	10	How to Simply Judge Whether Outdoor Fan Motor is Good or Bad

### 11-1. First Confirmation

#### 11-1-1. Confirmation of Power Supply

Confirm that the power breaker operates (ON) normally.

#### 11-1-2. Confirmation of Power Voltage

Confirm that power voltage is AC 220–230–240 ± 10%.

If power voltage is not in this range, the unit may not operate normally.

#### 11-1-3. Operation Which is not a Trouble (Program Operation)

For controlling the air conditioner, the program operations are built in the microcomputer as described in the following table.

If a claim is made for running operation, check whether or not it meets to the contents in the following table.

When it does, we inform you that it is not trouble of equipment, but it is indispensable for controlling and maintaining of air conditioner.

Table 11-1-1

No.	Operation of air conditioner	Description
1	When power breaker is turned "ON", the operation indicator (Green) of the signal receiving unit flashes.	The OPERATION lamp of the signal receiving unit flashes when power source is turned on. If [ ⏻ ] button is operated once, flashing stops. (Flashes also in power failure)
2	Compressor may not operate even if the room temperature is within range of compressor-ON.	The compressor does not operate while compressor restart delay timer (3-minutes timer) operates. The same phenomenon is found after power source has been turned on because 3-minutes timer operates.
3	In Dry and ECO mode, FAN (air flow) display does not change even though FAN (air flow select) button is operated.	The air flow indication is fixed to [AUTO].
4	In AUTO mode, the operation mode is changed.	After selecting Cool or Heat mode, select an operation mode again if the compressor keeps stop status for 15 minutes.

## 11-2. Primary Judgment

To diagnose the troubles, use the following methods.

- 1) Judgment by flashing LED of the signal receiving unit
- 2) Self-diagnosis by service check remote controller
- 3) Judgment of trouble by every symptom

Firstly use the method 1) for diagnosis. Then, use the method 2) or 3) to diagnose the details of troubles.

## 11-3. Judgment by Flashing LED of the signal receiving unit

While the indoor unit monitors the operation status of the air conditioner, if the protective circuit operates, the contents of self-diagnosis are displayed with block on the indoor unit indication section.

Table 11-3-1

	Item	Check code	Block display	Description for self-diagnosis
<div style="border: 1px solid black; padding: 5px; width: fit-content; margin-bottom: 5px;">the signal receiving unit indication lamp flashes.</div> <div style="text-align: center;">↓</div> <div style="border: 1px solid black; padding: 5px; width: fit-content; margin-bottom: 5px;">Which lamp does flash?</div> <div style="text-align: center;">↓</div> <div style="border: 1px solid black; padding: 5px; width: fit-content; margin-bottom: 5px;">C</div>	A	—	OPERATION (Green) Flashing display (1 Hz)	Power failure (when power is ON)
	B	00	OPERATION (Green) Flashing display (1 Hz)	Protective circuit operation for indoor P.C. board
	C	01	OPERATION (Green) TIMER (Orange) Flashing display (1 Hz)	Protective circuit operation for connecting cable and serial signal system
	D	02	OPERATION (Green) PRE.DEF (Orange) Flashing display (1 Hz)	Protective circuit operation for outdoor P.C. board
	E	03	OPERATION (Green) TIMER (Orange) PRE.DEF (Orange) Flashing display (1 Hz)	Protective circuit operation for others (including compressor)

### NOTES :

1. The contents of items B and C and a part of item E are displayed when air conditioner operates.
2. When item B and C, and item B and a part of item E occur concurrently, priority is given to the block of item B.
3. The check codes can be confirmed on the remote controller for servicing.

## 11-4. Self-Diagnosis by Remote Controller (Check Code)

1. If the lamps are indicated as shown B to E in Table 11-3-1, execute the self-diagnosis by the remote controller.
2. When the remote controller is set to the service mode, the indoor controller diagnoses the operation condition and indicates the information of the self-diagnosis on the display of the remote controller with the check codes. If a fault is detected, all lamps on the signal receiving unit flash at 5Hz and it will beep for 10 seconds (Beep, Beep, Beep ... ). The timer lamp usually flashes (5Hz) during self-diagnosis.

### 11-4-1. How to Use Remote Controller in Service Mode

**1** Press [CHECK] button with a tip of pencil to set the remote controller to the service mode.

- “00” is indicated on the display of the remote controller.

**2** Press [ON ▲] or [OFF ▲] button

If there is no fault with a code, the indoor unit will beep once (Beep) and the display of the remote controller will change as follows :

→ 00 → 01 → 02 ... 1d → 1E → 33

- The TIMER indicator of the signal receiving unit flashes continuously. (5 times per 1 sec.)
- Check the unit with all 52 check codes (00 to 33) as shown in Table-11-4-1.
- Press [ON ▼] or [OFF ▼] button to change the check code backward.

If there is a fault, the indoor unit will beep for 10 seconds (Beep, Beep, Beep...).

Note the check code on the display of the remote controller.

- 2-digits alphanumeric will be indicated on the display.
- All indicators on the signal receiving unit will flash. (5 times per 1 sec.)

**3** Press [CLR] button. After service finish for clear service code in memory.

- “7F” is indicated on the display of the remote control.

**4** Press [⏻] button to release the service mode.

- The display of the remote controller returns to as it was before service mode was engaged.

Alphanumeric characters are used for the check codes.

5 is 5.	6 is 6.
A is A.	B is B.
C is C.	D is D.

Fig. 9-4-1



### 11-4-2. Caution at Servicing

1. After servicing, press the [⏏] button to return to the normal mode.
2. After servicing by the check code, turn off breaker of the power supply, and turn on breaker of the power supply again so that memory in the microcomputer returns the initial status.  
However, the check codes are not deleted even if the power supply is turned off because they are stored in the fixed memory.
3. After servicing, press [CLR] button under check mode status and then send the check code "7F" to the indoor unit. The error code stored in memory is cleared.

Table 11-4-1

Block distinction		Operation of diagnosis function				Judgment and action
Check code	Block	Check code	Cause of operation	Air conditioner status	Remarks	
00	Indoor P.C. board etc.	0C	Short-circuit or disconnection of the room temperature sensor (TA sensor).	Operation continues.	Displayed when error is detected.	1. Check the room temp. sensor. 2. When the room temp. sensor is normal, check P.C. board.
		0d	Being out of place, disconnection, shortcircuit, or migration of heat exchanger sensor (TC sensor)	Operation continues.	Displayed when error is detected.	1. Check heat exchanger sensor. 2. When heat exchanger sensor is normal, check P.C. board.
		0F	Being out of place, disconnection, short-circuit, or migration of heat exchanger sensor (TCJ sensor).	Operation continues.	Displayed when error is detected.	1. Check heat exchanger sensor. 2. When heat exchanger sensor is normal, check P.C. board.
		11	Lock of indoor fan or trouble on the indoor fan circuit	All off	Displayed when error is detected.	1. Check the motor. 2. When the motor is normal, check P.C. board.
		0b	Float SW operation	Operation continues. (Outdoor units stop.)	Displayed when error is detected.	1. Check the drainage. 1) Amount of residual drain. 2) Drain water piping installation situation. 2. Float SW operation check 3. Check disconnection of connector.
	Not displayed	12	Trouble on other indoor P.C. boards	Operation continues.	Displayed when error is detected.	Replace P.C. board.
	Wired Remote Controller	30	Communication with wired remote controller is error.		Displayed when error is detected.	Check wired remote controller connection.
Indoor P.C. board	31	Capacity Date is not set.		Displayed when error is detected.	Set Function Code 11 properly.	
01	Connecting cable and serial signal	04	Return serial signal is not sent to indoor side from operation started. 1) Defective wiring of connecting cable 2) Operation of compressor thermo Gas shortage Gas leak	Operation continues.	Flashes when trouble is detected on Return serial signal, and normal status when signal is reset.	1. When the outdoor unit never operate: 1) Check connecting cable, and correct if defective wiring. 2) Check fuse of inverter P.C. board. 2. To display [Other] block during operation, check compressor thermo. operation and supply gas (check gas leak also). 3. Unit operates normally during check. If return serial signal does not stop between indoor terminal 2 and 3, replace inverter P.C. board. If signal stops between indoor terminal 2 and 3, replace indoor P.C. board.

Block distinction		Operation of diagnosis function				Judgment and action
Check code	Block	Check code	Cause of operation	Air conditioner status	Remarks	
02	Outdoor P.C. board	14	Inverter over-current protective circuit operates. (Short time)	All off	Displayed when error is detected.	Even if trying operation again, all operations stop immediately. : Replace P.C. board.
		15	Position-detect circuit error or short-circuit between windings of compressor	All off	Displayed when error is detected.	1. Even if connecting lead wire of compressor is removed, position-detect circuit error occurred. : Replace P.C. board. 2. Measure resistance between wires of compressor, and perform short-circuit. : Replace compressor.
		17	Current-detect circuit error	All off	Displayed when error is detected.	Even if trying operation again, all operations stop immediately. : Replace P.C. board.
		18	Being out of place, disconnection or shortcircuit of the outdoor heat exchanger sensor (TE) or suction temp. sensor (Ts)	All off	Displayed when error is detected.	1. Check sensors (TE, TS). 2. Check P.C. board.
		19	Disconnection or shortcircuit of discharge temp. sensor (Td)	All off	Displayed when error is detected.	1. Check discharge temp. sensor (TD). 2. Check P.C. board
		1A	Outdoor fan drive system error	All off	Displayed when error is detected.	Position-detect error, over-current protective operation of outdoor fan drive system, fan lock, etc. : Replace P.C. board or fan motor.
	Not displayed	16	Outdoor heat exchanger temp. sensor error	Operation continues	—	1. Check outdoor temp. sensor (TO). 2. Check P.C. board.
Outdoor P.C. board	1E	Compressor drive output error, Compressor error (lock, missing, etc.), Break down	All off	Displayed when error is detected.	When 20 seconds passed after start-up, position-detect circuit error occurred. : Replace compressor. Trouble on P.M.V.	

Block distinction		Operation of diagnosis function				Judgment and action
Check code	Block	Check code	Cause of operation	Air conditioner status	Remarks	
03	Others (including compressor)	07	Return serial signal has been sent when operation started, but it is not sent from halfway. 1) Compressor thermo. operation Gas shortage Gas leak 2) Instantaneous power failure	Operation continues	Flashes when trouble is detected on return serial signal, and normal status when signal is reset.	1. Repeat Start and Stop with interval of approx. 10 to 40 minutes. (Code is not displayed during operation.) Supply gas. (Check also gas leak). 2. Unit operates normally during check. If return serial signal does not stop between indoor terminal block 2 and 3, replace inverter P.C. board. If signal stops between indoor terminal block 2 and 3, replace indoor P.C. board.
		1d	Compressor does not rotate. (Current protective circuit does not operate when a specified time passed after compressor had been activated.)	All off	Displayed when error is detected.	1. Trouble on compressor 2. Trouble on wiring of compressor (Missed phase)
		1E	Discharge temp. exceeded 117°C	All off	Displayed when error is detected.	1. Check discharge temp. sensor (TD). 2. Gas leakage 3. Trouble on P.M.V.
		1F	Break down of compressor	All off	Displayed when error is detected.	1. Check power voltage. (220–230–240 V +10%) 2. Overload operation of refrigeration cycle Check installation condition (Short-circuit of outdoor diffuser).

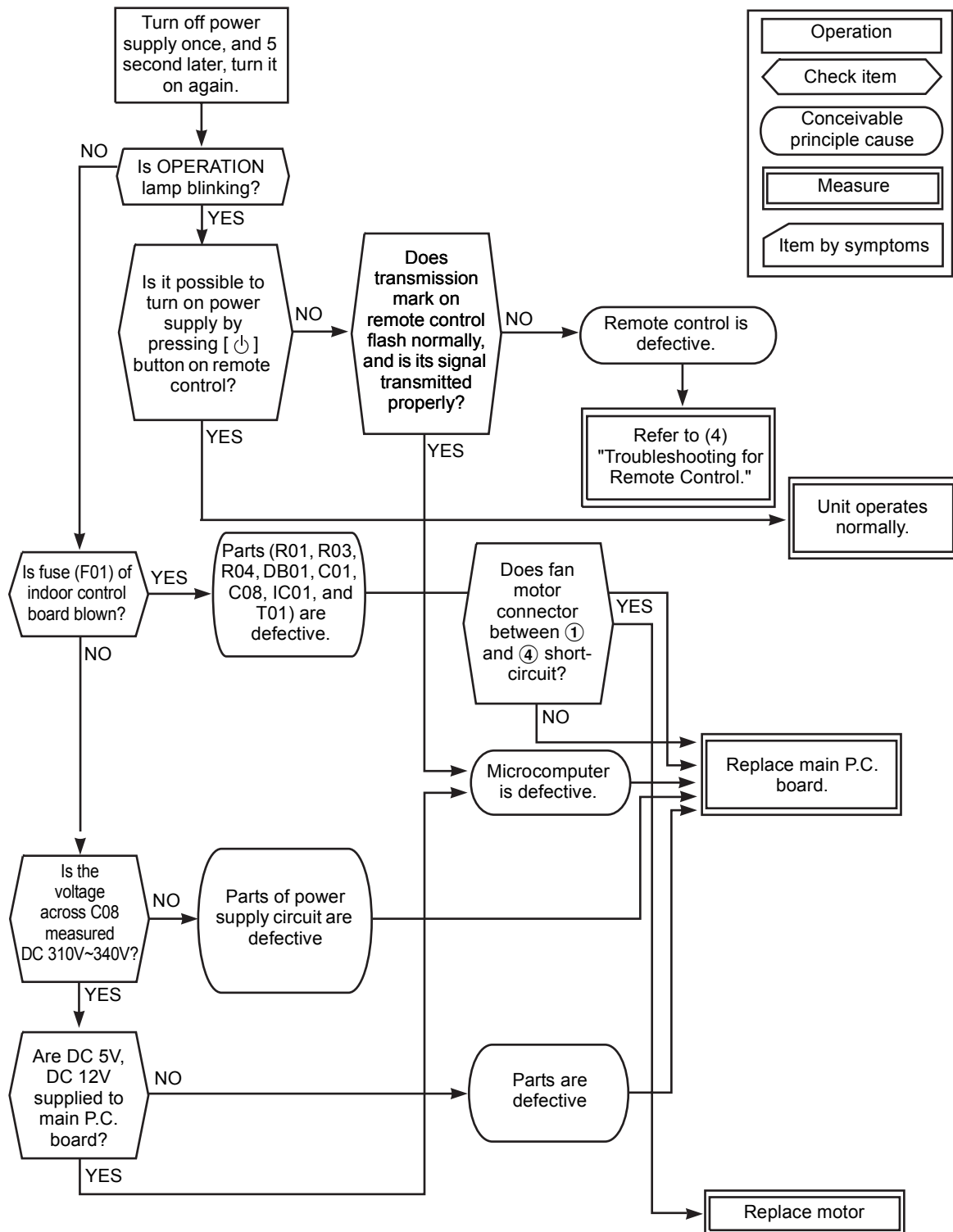
## 11-5. Judgment of Trouble by Every Symptom

### 11-5-1. Indoor Unit (Including Remote Controller)

#### (1) Power is not turned on (Does not operate entirely)

##### <Primary check>

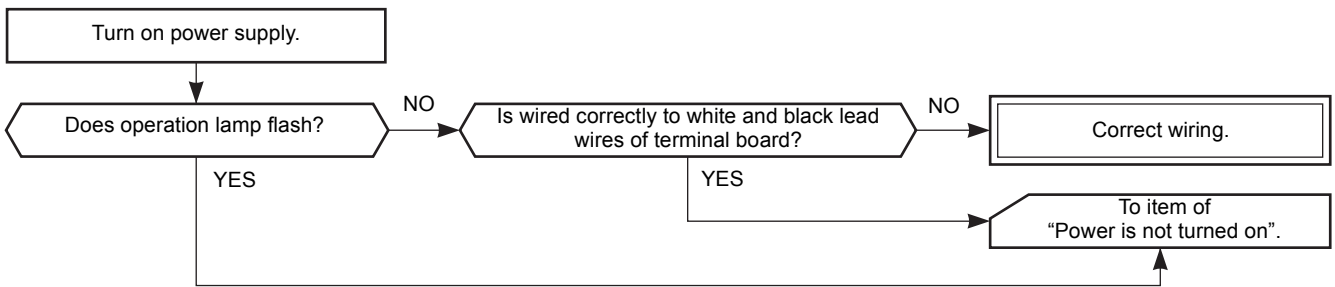
1. Is the supply voltage normal?
2. Is the normal voltage provided to the outdoor unit?
3. Is the crossover cable connected properly?
4. Is the fuse (F01) blown?



- Be sure to disconnect the motor connector CN210 after shut off the power supply, or it will be a cause of damage of the motor.

**(2) Power is not turned on though Indoor P.C. board is replaced**

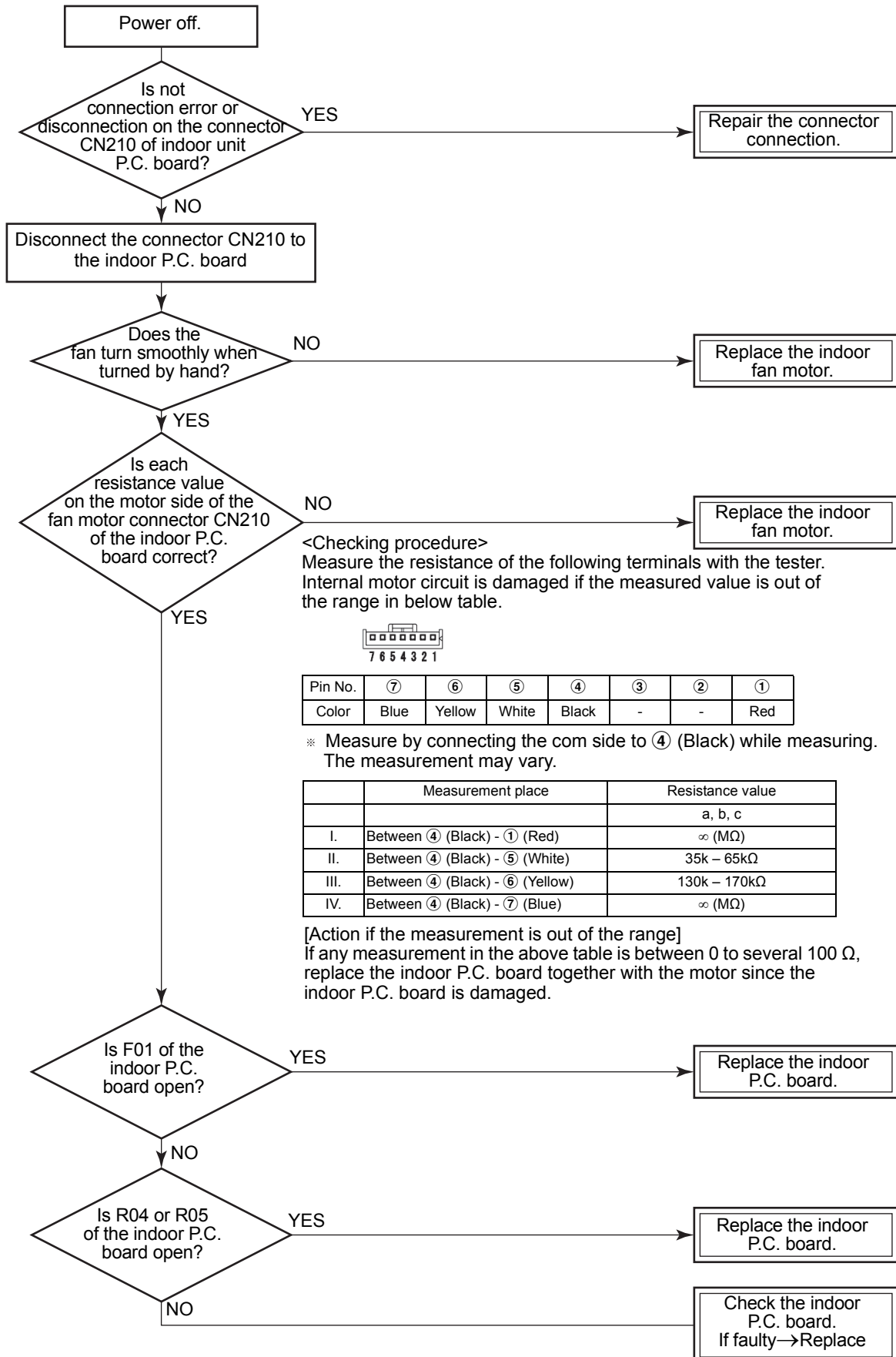
**<Confirmation procedure>**



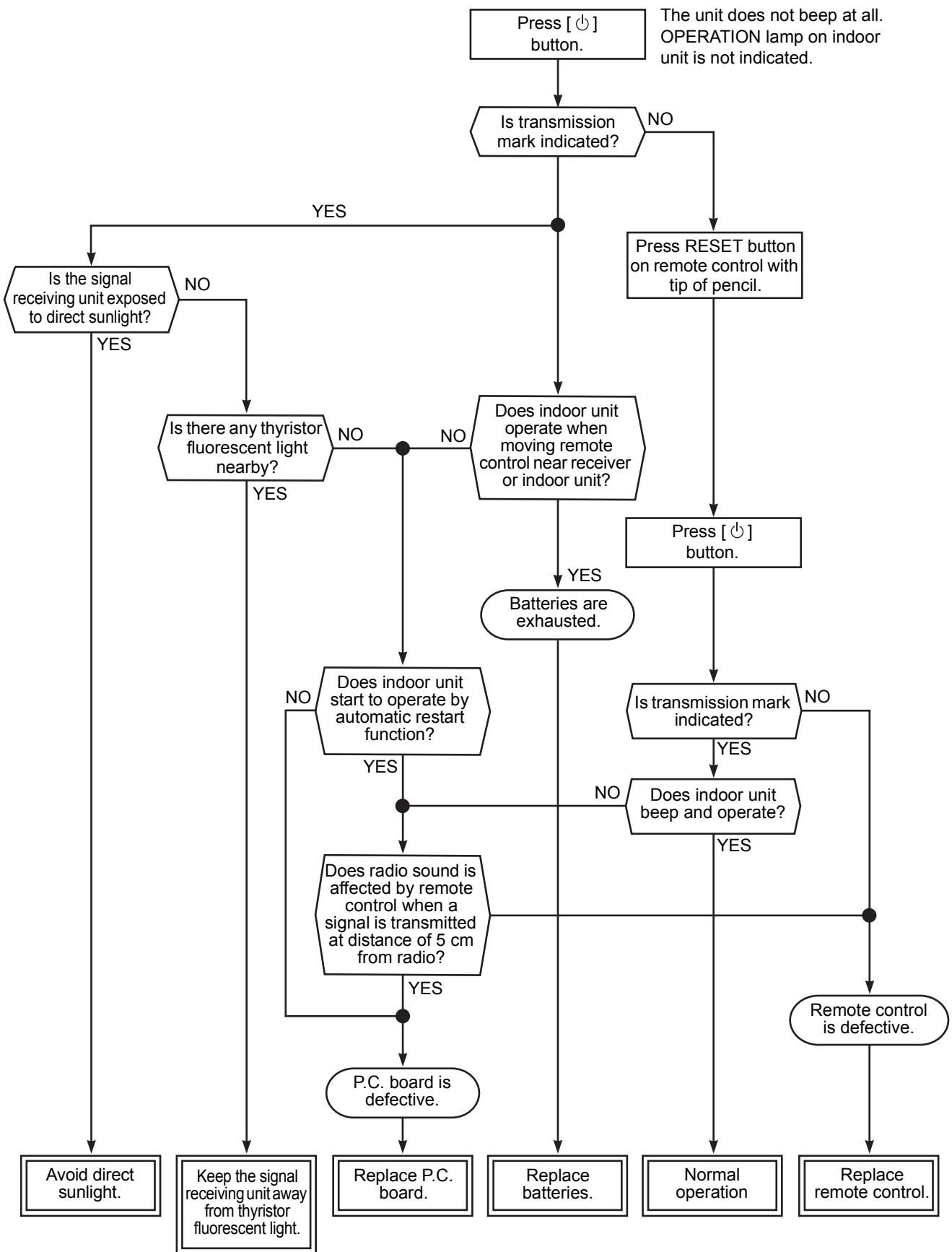
### (3) Only the indoor motor fan does not operate

#### <Primary check>

1. Is it possible to detect the power supply voltage (AC220–240V) between ① and ② on the terminal block?
2. Does the indoor fan motor operate in cooling operation?  
(In heating operation, the indoor fan motor does not operate for approximately 10 minutes after it is turned on, to prevent a cold air from blowing in.)



**(4) Troubleshooting for remote control**



## 11-6. How to Check Simply the Main Parts

### 11-6-1. How to Check the P.C. Board (Indoor Unit)

#### (1) Operating precautions

- 1) When removing the P.C. board, be sure to shut off the power supply breaker.
- 2) When removing the P.C. board, hold the edge of the P.C. board and do not apply force to the parts.
- 3) When connecting or disconnecting the connectors on the P.C. board, hold the whole housing. Do not pull at the lead wire.

#### (2) Inspection procedures

- 1) When a P.C. board is judged to be defective, check for disconnection, burning, or discoloration of the copper foil pattern on this P.C. board.
- 2) The P.C. board consists of the following 2 parts

##### a. Main P.C. board part :

DC power supply circuit, Indoor fan motor control circuit, CPU and peripheral circuits, buzzer.

##### b. The signal receiving unit of infrared ray receiving infrared ray receiving circuit, LED :

To check defect of the P.C. board, follow the procedure described below.

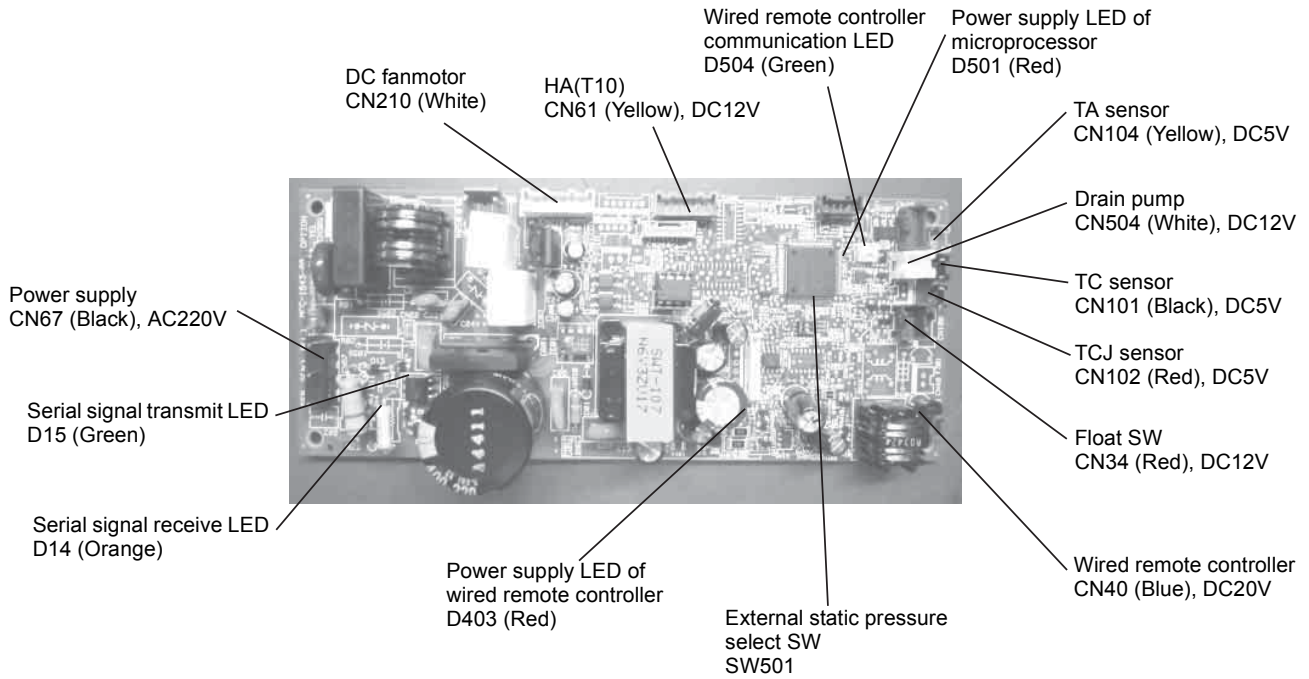


### (3) Check procedures

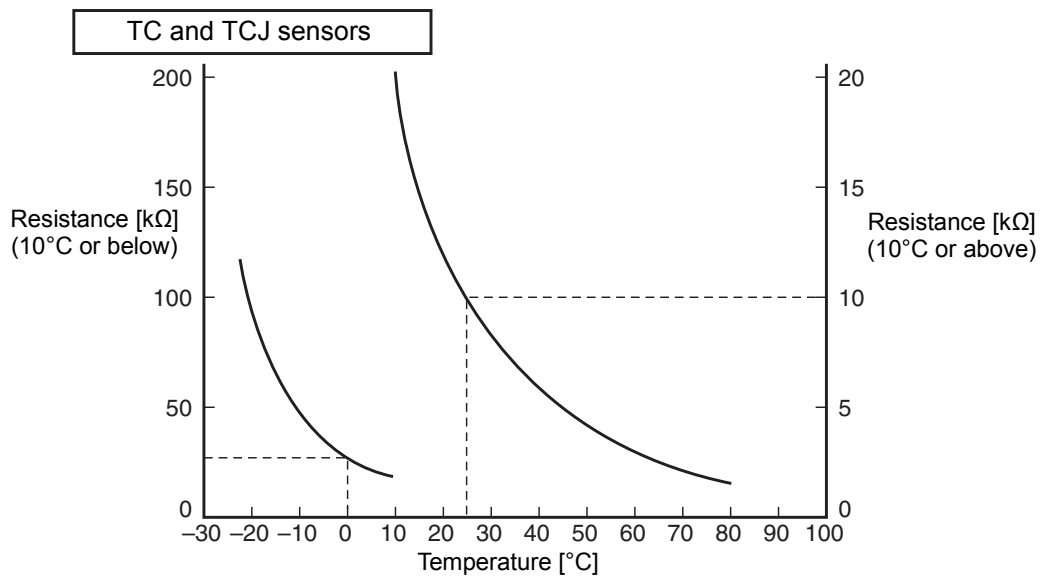
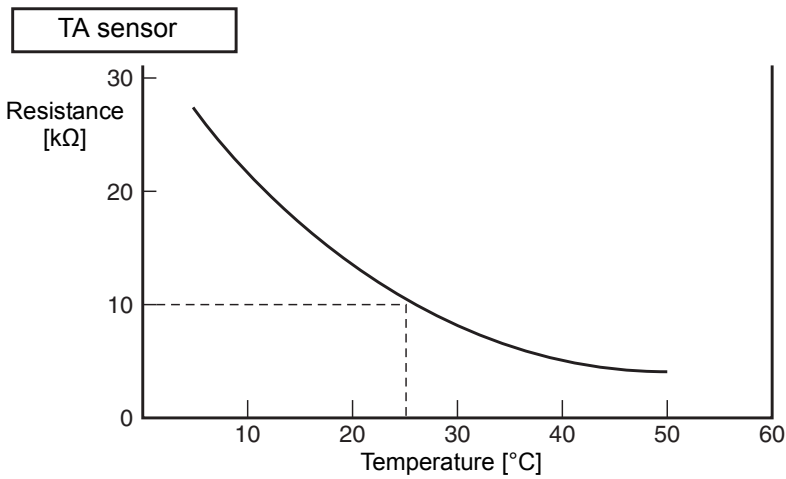
Table 11-6-1

No.	Procedure	Check points	Causes
1	Turn off the power supply breaker and remove the P.C. board assembly from electronic parts base. Remove the connecting cables from the terminal block.	Check whether or not the fuse (F01) is blown.	Impulse voltage was applied or the indoor fan motor short-circuited.
2	Remove the connector of the motor and turn on the power supply breaker. If OPERATION indicator flashes (once per second), it is not necessary to check steps (1 to 3) in the right next column.	Check power supply voltage : 1. Between No. 1 and No. 3 of CN67 (AC 220–240V) 2. Between ⊕ and ⊖ of CN08 (DC 310–340V) 3. Between 12V and GND 4. Between 5V and GND	1. The terminal block or the crossover cable is connected wrongly. 2. The capacitor (C01) Varistor (R01), line filter (L01), resistor (R03,R04), or the diode (DB01) is defective. 3. T01 is defective. 4. IC01,IC02 and T01 are defective.
3	Push [ ⏻ ] button once to start the unit. (Do not set the mode to On-Timer operation.)	Check power supply voltage : 1. Between No.1 and No.3 of CN67 (DC 15–60V)	IC08 and IC09 are defective.
4	Shorten the restart delay timer and start unit.	Check whether or not all indicators (OPERATION, TIMER, PRE. DEF, Hi POWER) are lit for 3 seconds and they return to normal 3 seconds later.	The indicators are defective or the housing assembly (CN214) is defective.
5	Push [ ⏻ ] button once to start the unit. • Shorten the restart delay timer. • Set the operation mode to COOL. • Set the fan speed level to AUTO. • Set the preset temperature much lower than the room temperature. (The unit (compressor) operates continuously in the above condition.)	1. Check whether or not the compressor operates. 2. Check whether or not the OPERATION indicator flashes.	1. The temperature of the indoor heat exchanger is extremely low. 2. The connection of the heat exchanger sensor is loose. (The connector is disconnected.) (CN101,CN102) 3. The heat exchanger sensor and the P.C. board are defective. (Refer to Table 11-4-1.) 4. The main P.C. board is defective.
6	Connect the motor connector to the motor and turn on the power supply. Start the unit the following condition. • Set the fan speed level to HIGH. (The unit (compressor) operates continuously in the above condition in No. 5.)	1. Check it is impossible to detect the voltage (DC15V) between No.4 and No.5 of the motor terminals. 2. The motor does not operate or the fan motor does not rotate with high speed. (But it is possible to receive the signal from the remote controller.) 3. The motor rotates but vibrates strongly.	1. The indoor fan motor is defective. (Protected operation of P.C. board.) 2. The P.C. board is defective. 3. The connection of the motor connector is loose.

## 11-6-2. P.C . Board Layout



### [1] Sensor characteristic table



### 11-6-3. Indoor Unit (Other Parts)

No.	Part name	Checking procedure												
1	Room temp. (TA) sensor Heat exchanger (TC) sensor	Disconnect the connector and measure the resistance value with tester. (Normal temp.) <table border="1" data-bbox="574 342 1422 427"> <thead> <tr> <th>Sensor \ Temperature</th> <th>10°C</th> <th>20°C</th> <th>25°C</th> <th>30°C</th> <th>40°C</th> </tr> </thead> <tbody> <tr> <td>TA, TC (kΩ)</td> <td>20.7</td> <td>12.6</td> <td>10.0</td> <td>7.9</td> <td>4.5</td> </tr> </tbody> </table>	Sensor \ Temperature	10°C	20°C	25°C	30°C	40°C	TA, TC (kΩ)	20.7	12.6	10.0	7.9	4.5
Sensor \ Temperature	10°C	20°C	25°C	30°C	40°C									
TA, TC (kΩ)	20.7	12.6	10.0	7.9	4.5									
2	Remote controller	Refer to 11-5-1. (4).												
3	Indoor fan motor	Refer to 11-5-1. (3).												

## 12. HOW TO REPLACE THE MAIN PARTS

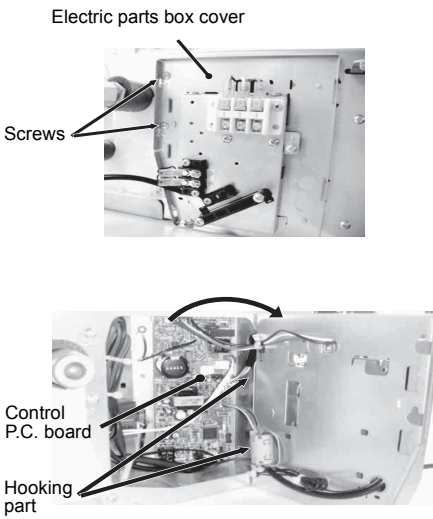
### ⚠ WARNING

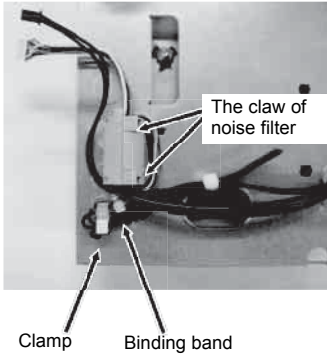
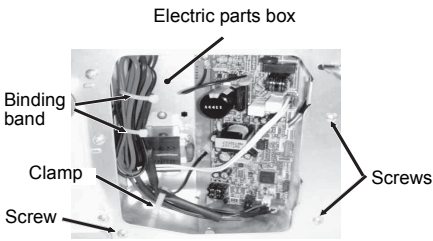
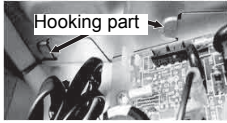
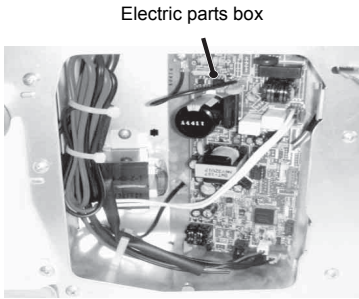
Be sure to stop operation of the air conditioner before work and then turn off switch of the breaker.

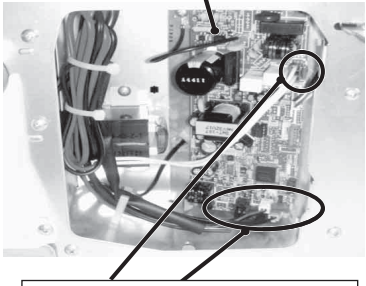
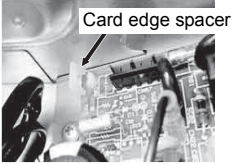
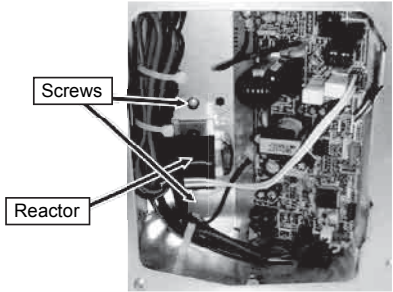
### ⚠ CAUTION

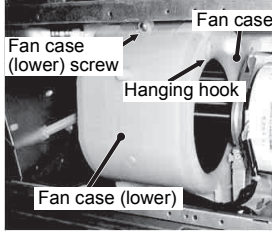
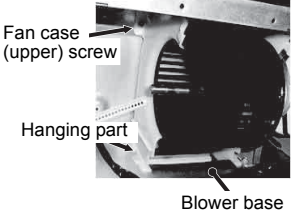
Be sure to put on gloves during working time; otherwise an injury will be caused by a part, etc.

No.	Part name	Procedure	Remarks
①	Suction panel	<p><b>1. Detachment</b></p> <p>1) Holding the suction panel with your hand, remove the screws fixing the panel in place.</p> <p><b>NOTE)</b></p> <ul style="list-style-type: none"> <li>• Be careful that the suction panel doesn't fall while at work.</li> <li>• For the back air intake, remove the screws (2 locations) used to fix the fan case (lower) in place as well.</li> </ul> <p><b>2. Attachment</b></p> <p>1) While holding the suction panel with your hand so that the panel does not fall off, tighten the screws that you removed in step 1-1) of "① Suction panel."</p>	
②	Terminal cover	<p><b>1. Detachment</b></p> <p>1) Slightly loosen the screw holding the terminal cover in place. (Ø4×10 1 pcs)</p> <p>2) Lifting the terminal cover upward, pull the right side of the cover toward you and then disengage the claws on the left side of the cover from their slits to detach the terminal cover.</p> <p><b>2. Attachment</b></p> <p>1) Insert the claws on the left side of the terminal cover into their slits.</p> <p>2) Moving the terminal cover downward, insert the cover in the gap between the terminal box and screw that you loosened in step 1-1) of "② Terminal cover" and tighten the screw to fix the cover in place.</p>	

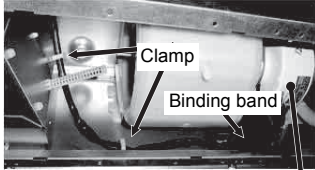
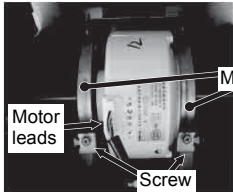

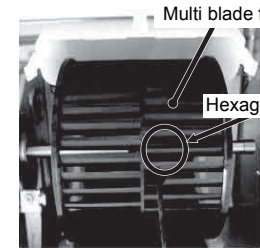
No.	Part name	Procedure	Remarks
③	Electric parts box cover	<p><b>1. Detachment</b></p> <p>1) Perform step 1 of “②Terminal cover” as required. (You may be able to perform this procedure without removing the electric parts box cover.)</p> <p>2) Slightly loosen the screw holding the electric parts box cover in place. (Ø4×10 2 pcs)</p> <p>3) Lifting the electric parts box cover upward, pull the left side of the cover toward you to open it.</p> <p><b>NOTE)</b> If it is difficult to open the electric parts box cover because of the power supply and communication cables connected to the cover, disconnect these cables and perform the procedure.</p> <p>4) Disconnect the following connectors from the control P.C. board.</p> <p><b>NOTE)</b> Unlock the lock of the housing to disconnect the connectors. CN41 ... Remote control connector (2P: Blue) CN67 ... Power supply connector (5P: Black) CN214...Signal receiving lead wire (9P: White)</p> <p>5) Lift the electric parts box cover upward and pull the cover to the left toward you to detach it from the claws on the right side.</p> <p><b>2. Attachment</b></p> <p>1) Insert the hooking plates of the main body into the hook holes on the right side of the electric parts box cover.</p> <p>2) Reconnect the cables that you disconnected in step 1-4) of “③Electric parts box cover.”</p> <p>3) Moving the electric parts box cover downward, close the electric parts box cover. Insert the cover in the gap between the box and screws that you loosened in step 1-2) of “③Electric parts box cover” and use the screws to fix the cover into place.</p>	 <p>The top photograph shows the electric parts box cover being loosened from the main body. Two screws are indicated by arrows and labeled 'Screws'. The cover is labeled 'Electric parts box cover'. The bottom photograph shows the cover being lifted and pulled to the left. A curved arrow indicates the upward and leftward movement. Labels 'Control P.C. board' and 'Hooking part' point to the internal components and the attachment mechanism respectively.</p>

④	NOISE FILTER	<p><b>1. Detachment</b></p> <ol style="list-style-type: none"> <li>1) Perform the procedure in 1 of “③ Electric parts box cover.”</li> <li>2) Remove the binding band from clamp.</li> <li>3) The claw of the noise filter (two places) is removed and remove from the signal receiving unit lead wire.</li> </ol> <p><b>2. Attachment</b></p> <ol style="list-style-type: none"> <li>1)The signal receiving unit lead wire is wrapped around the noise filter twice. And, the claw of the noise filter is locked.</li> <li>2)The clamp is fixed to the signal receiving unit lead wire by the binding band.</li> </ol>	
⑤	Electric parts box	<p><b>1. Detachment</b></p> <ol style="list-style-type: none"> <li>1) For the back air intake, perform the procedure in 1 of “①Suction panel.”</li> <li>2) Perform the procedure in 1 of “③Electric parts box cover.”</li> <li>3) Remove the binding bands and clamps inside the electric parts box.</li> <li>4) Remove the screws that fix the electric parts box into place. (<math>\varnothing 4 \times 10</math> 3 pcs) The electric parts box will not fall off even when the screws are removed.</li> <li>5) Move the electric parts box in the direction opposite to the air blow-off port side to disengage the hooking plates and then remove the electric parts box from the under air intake side.</li> </ol> <p><b>2. Attachment</b></p> <ol style="list-style-type: none"> <li>1) Insert the hooking plates of the electric parts box into the hooking parts of the main body.</li> <li>2) Carefully restore the electric parts box to its original state without getting the cables caught by the box. Fix the box using the screws that you removed in step 1-4) of “⑤Electric parts box.”</li> </ol> <p><b>NOTE)</b> Make sure that the hooking plates are securely inserted into the hooking parts of the electric parts box. (Hooking plates: 2 locations)</p> <p><b>NOTE)</b> Make sure to securely fix the clamps and binding bands of the cables that you disconnected.</p>	  

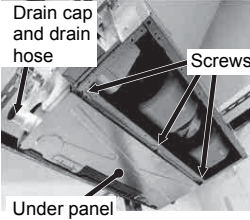
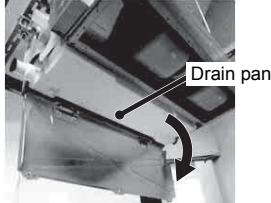
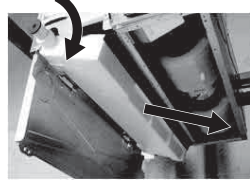
No.	Part name	Procedure	Remarks
⑥	Control P.C. board	<p><b>1. Detachment</b></p> <p>1) Perform the procedure in 1 of “③ Electric parts box cover.”</p> <p>2) Disconnect the connectors from other components from the control P.C. board.</p> <p><b>NOTE)</b> Unlock the lock of the housing to disconnect the connectors.</p> <p>CN41 ... Remote control connector (2P: Blue)  CN67 ... Power supply connector (5P: Black)  CN101 ... TC sensor (2P: Black)  CN102 ... TCJ sensor (2P: Red)  CN104 ... TA sensor (2P: Yellow)  CN210 ... Fan motor power supply (7P: White)  CN34 ... Float switch (3P: Red)  CN504 ... Drain pump lead (2P: White)  CN01...Reactor (2P: Blue)</p> <p>3) Unlock the card edge spacers (4 locations) to remove the control P.C. board.</p> <p><b>2. Attachment</b></p> <p>1) Attach the control P.C. board to the clamps.</p> <p>2) Reconnect the cables that you disconnected in step 1-2) of “⑥ Control P.C. board.”</p> <p><b>NOTE)</b> Check there is no missing or contact failure on the connectors.</p>	<p>Electric parts box</p>  <p>If it is difficult to disconnect the bottom connector, first remove the card edge spacers (2 locations at bottom), and then proceed.</p>  <p>Card edge spacer</p>
⑦	Reactor	<p><b>1. Detachment</b></p> <p>1) Perform the procedure in 1 of “③ Electric parts box cover.”</p> <p>2) The connector of reactor (CN01) is removed from control P.C. board.</p> <p>3) Remove the screws that fix the reactor. (Ø4×10 2 pcs)</p> <p><b>2. Attachment</b></p> <p>1) Attach the reactor to the control P.C. board.</p> <p>2) Reconnect the detached connector.</p> <p><b>NOTE)</b> Check there is no missing or contact failure on the connectors.</p>	 <p>Screws</p> <p>Reactor</p>

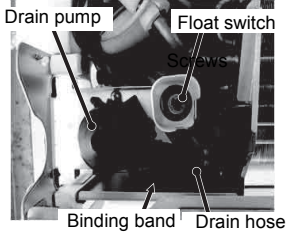
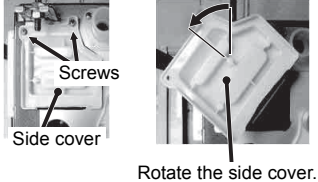
No.	Part name	Procedure	Remarks
⑧	Fan case (lower), Fan case (upper)	<p><b>1. Detachment</b></p> <ol style="list-style-type: none"> <li>1) For the back air intake, perform the procedure in 1 of “① Suction panel.”</li> <li>2) Remove the screw on the rear of the fan case (lower). (One Ø4×10 screw for each fan case)</li> <li>3) Disengage the hanging hooks on both sides of the fan case (lower) to remove the fan case (lower).</li> <li>4) Remove the screws used to attach the fan case (upper). (Two Ø4×10 left and right screws for each fan case)</li> <li>5) Move the hooking plate of the fan case (upper), which is hooked to the blower base, downward to remove the fan case (upper).</li> </ol> <p><b>2. Attachment</b></p> <ol style="list-style-type: none"> <li>1) Use the hooking plate to hook the fan case (upper) to the blower base to attach the fan case (upper).</li> </ol> <p><b>NOTE)</b> Make sure the fan case (upper) does not move even if you pull on it.</p> <ol style="list-style-type: none"> <li>2) Use the screws that you removed in step 1-4) of “⑧ Fan case (lower/upper)” to attach the fan case (upper).</li> <li>3) Insert the tip of the fan case (lower) into the blower base and use the hooking plate to attach the fan case.</li> <li>4) Use the screws that you removed in step 1-2) of “⑧ Fan case (lower/upper)” to attach the fan case (upper).</li> </ol>	 



No.	Part name	Procedure	Remarks
⑨	Fan motor, Multi blade fan	<p><b>1. Detachment</b></p> <p>1) For the back air intake, perform the procedure in 1 of “① Suction panel.”</p> <p>2) Perform the procedure in steps 1-1), 1-2), 1-3) of “③ Electric parts box cover.”</p> <p>3) Disconnect the following connector of the control P.C. board.</p> <p><b>NOTE)</b> Unlock the lock of the housing to disconnect the connectors. CN210 ... Fan motor power supply (5P: White)</p> <p>4) Detach the clamps and binding bands of the cable.</p> <p>5) Perform the procedure in steps 1-2), 1-3) of “⑥ Fan case (lower/upper).”</p> <p>6) Remove the screws of the motor bands. (<math>\varnothing 5 \times 10</math> 2 pcs) The motor band will not fall off even when the screws are removed.</p> <p>7) Hold the motor bands with your hand so that they do not fall off, and remove the bands.</p> <p>8) Loosen the hexagonal hole screw of the multi blade fan and remove the fan from the shaft.</p> <p><b>2. Attachment</b></p> <p>1) Insert the fan motor shaft into the multi blade fan, and secure it loosely. With the shaft still loosely secured, assemble the fan motor, and secure it using the motor band.</p> <p><b>NOTE)</b> When assembling the fan motor, ensure that the motors leads are positioned on the left side facing the drain pan, and assemble the motor so that the motor leads are pointing straight down.</p> <p>2) Align the position of the multi blade fan so that it is positioned at the center of the fan case (upper) and fix the fan using the hexagonal hole screw.</p>	    <p>(Drain pan side)</p>

No.	Part name	Procedure	Remarks
⑨	Fan motor, Multi blade fan	<p><b>NOTE)</b> Arrange the multi blade fan so that screws position at the right side against the drain pan.</p> <p><b>NOTE)</b> Fix multi blade fan with torque wrench 4.9 N•m or more.</p> <p>3) Perform the procedure in steps 2-3) and 2-4) of “⑧ Fan case (lower/upper)” to attach the fan case (lower).</p> <p>4) Reconnect the cables that you disconnected in steps 1-3) and 1-4) of “⑨ Fan motor, Multi blade fan”.</p> <p><b>NOTE)</b> Check there is no missing or poor contact of the connectors. Finally check whether the multi blade fan turns surely and smoothly or not.</p>	

No.	Part name	Procedure	Remarks
⑩	Under panel, Drain pan	<p><b>1. Detachment</b></p> <p>1) Take off the drain cap and drain the drain water accumulated in the drain pan. In case of natural drain model, drain the drain water by taking off hose band and drain hose.</p> <p><b>NOTE)</b> When taking off drain cap and drain hose, be sure receive drain water in a bucket, etc.</p> <p>2) Slightly loosen the screw holding the under panel in place. (Ø4×10 3 pcs)</p> <p>3) Move the under panel toward the air intake side to hang the panel.</p> <p>4) Pull out the drain pan.</p> <p><b>NOTE)</b></p> <ul style="list-style-type: none"> <li>• When pulling out the drain pan, never pull out the drain socket by drawing it with hands. If doing so, water leak may be caused.</li> <li>• When pulling out the drain pan, some drain water may still be left in the pan so be absolutely sure to discard this water.</li> </ul> <p>5) After pulling out the drain pan slightly, pull it out again toward the air intake side to detach the pan.</p> <p><b>2. Attachment</b></p> <p>1) Hook the drain pan to the flange portion of the air intake side to attach the pan, and then push it in.</p> <p>2) Hook the under panel on the screws that you untightened in step 1-2) of “⑩Under panel, Drain pan” and tighten these screws.</p> <p>3) Attach the drain cap and drain hose that you removed in step 1-1) of “⑩Under panel, Drain pan.” When you attach the drain cap and drain hose, be sure to insert them firmly into the base of the drain socket of the drain pan.</p> <p><b>NOTE)</b> Finally, be sure to check there is no water leakage from each attached part.</p>	  

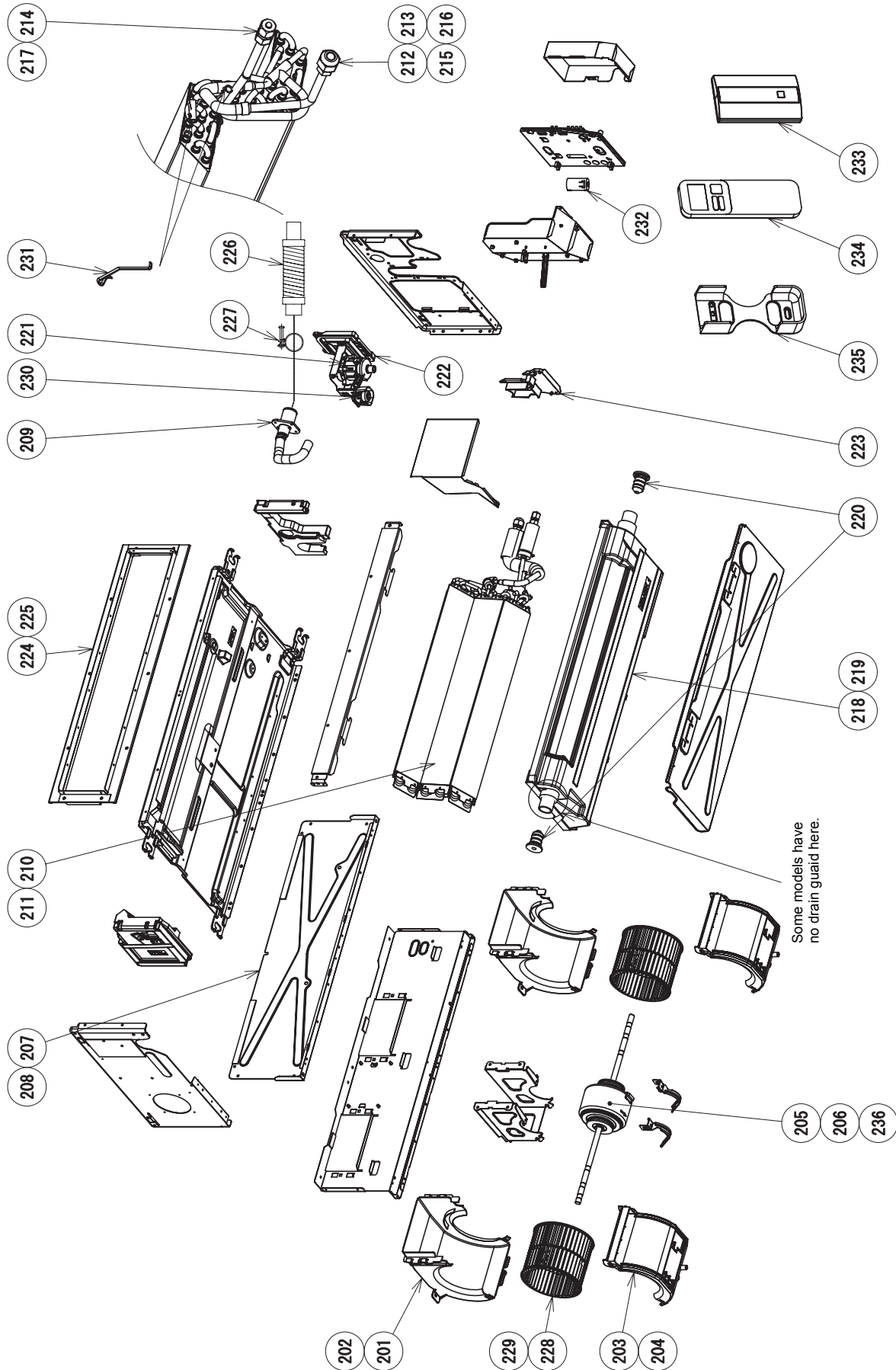
No.	Part name	Procedure	Remarks
⑪	Drain pump, Float switch, Drain hose  * For only drain pump incorporated model	<p><b>1. Detachment</b></p> <ol style="list-style-type: none"> <li>1) Perform the procedure in steps 1-1), 1-2), 1-3) of “③Electric parts box cover” and 1 of “⑩Under panel, Drain pan.”</li> <li>2) Disconnect the following connectors and connected cables from the control P.C. board.</li> </ol> <p><b>NOTE)</b>            Unlock the lock of the housing to disconnect the connectors.            CN34 ... Float switch (3P: Red)            CN504 ... Drain pump lead (2P: White)</p> <ol style="list-style-type: none"> <li>3) Detach the binding bands to disconnect the drain hose.</li> <li>4) Detach the binding bands that bundle the drain pump and float switch cables and pull in the cables from the control P.C. board.</li> <li>5) Remove the screws that fix the side cover. (Ø4×10 2 pcs)</li> <li>6) Detach the side cover from the side plate and then rotate the cover. Next, pull out the drain pump and other drain pump kit components from the side.            (The drain pump and other drain pump kit components are fixed to the side cover.)</li> </ol> <p><b>NOTE)</b></p> <ul style="list-style-type: none"> <li>• If the pipes are damaged, refrigerant leak may be caused. Take out them with great care.</li> <li>• One of two methods can be used: Either pull out the drain pump from the side or remove the screws (3 locations) used to fix the drain pump in place from the bottom side, and take out the drain pump from the bottom side.</li> </ul> <p><b>2. Attachment</b></p> <ol style="list-style-type: none"> <li>1) Carefully insert the side cover (which fixes the drain pump and other drain pump kit components removed in step 1-5) of “⑪Drain pump, Float switch, Drain hose”) from the side, so that you do not damage the pipes. Then fix the side cover using the screws.</li> <li>2) Insert the drain hose into the port of the drain pump and fix the hose using the binding bands.</li> <li>3) Reconnect the cables and then perform the procedure in 2 of “⑩Under panel, Drain pan.”</li> </ol> <p><b>NOTE)</b>            Finally check whether they correctly operate or not.</p>	 

No.	Part name	Procedure	Remarks
⑫	Heat exchanger	<p><b>1. Detachment</b></p> <ol style="list-style-type: none"> <li>1) Recover refrigerant, and then remove refrigerant pipes at indoor unit side.</li> <li>2) Perform the procedure in steps 1-1), 1-2), 1-3) of “③ Electric parts box cover” and 1 of “⑩ Under panel, Drain pan.”</li> <li>3) Disconnect the following connector of the control P.C. board.</li> </ol> <p><b>NOTE)</b> Unlock the lock of the housing to disconnect the connectors.</p> <ol style="list-style-type: none"> <li>4) Remove the TC and TCJ sensors from the heat exchanger, and then detach the binding bands used for fixing cables, such as the sensor cables, and drain pump cable.</li> <li>5) Remove the screws of the pipe cover. Next lift up the pipe cover and disengage the cover from the hooking parts to remove it. (<math>\varnothing 4 \times 10</math> 2 pcs)</li> <li>6) Remove the screws of the side cover to which the drain pump is attached, and slightly pull out the side cover. (<math>\varnothing 4 \times 10</math> 2 pcs)</li> <li>7) Remove the screws of the heat exchanger fixed plate (U pipe side), which are used for fixing the end plate of heat exchanger. (<math>\varnothing 4 \times 10</math> 2 pcs)</li> <li>8) Remove the screws of the heat exchanger fixed plate (pipe side) and detach the plate (pipe side). (<math>\varnothing 4 \times 10</math> 3 pcs)</li> </ol> <p><b>NOTE)</b></p> <ul style="list-style-type: none"> <li>• One screw (1 location) is concealed by the drain pump. Shift the drain pump slightly in order to remove the screw.</li> <li>• If it is difficult to remove the screws on the U pipe side, remove the under panel.</li> <li>• When removing the top side screw on the U pipe side, use a longish screwdriver as necessary. Also, when removing the upper side screw, use a shortish screwdriver.</li> </ul> <ol style="list-style-type: none"> <li>9) Detach the heat exchanger.</li> </ol> <p><b>2. Attachment</b></p> <ol style="list-style-type: none"> <li>1) Restore the components and cables to their original conditions and fix them in the following order: Sensors → Heat exchanger → Heat exchanger fixed plate (pipe side) → Heat exchanger fixed plate (Use the screws to fix the plate to the U pipe side.) → Pipe cover → Side cover → Drain pump → Under panel.</li> <li>2) Connect the refrigerant pipe as before, and then perform vacuuming.</li> </ol>	<p>Sensors</p> <p>Binding band</p> <p>Pipe cover</p> <p>Hooking part</p> <p>Screws</p> <p>Heat exchanger</p> <p>Heat exchanger fixed plate (pipe side)</p> <p>Heat exchanger fixed plate (U pipe side)</p> <p>Heat exchanger fixed plate (pipe side) screws</p> <p>Move the drain pump slightly.</p> <p>Top side screw</p> <p>Under side screw</p> <p>Locations of screws as viewed from the air outlet side</p> <p>Heat exchanger fixed plate (U pipe side) screws</p>

# 13. EXPLODED VIEWS AND PARTS LIST

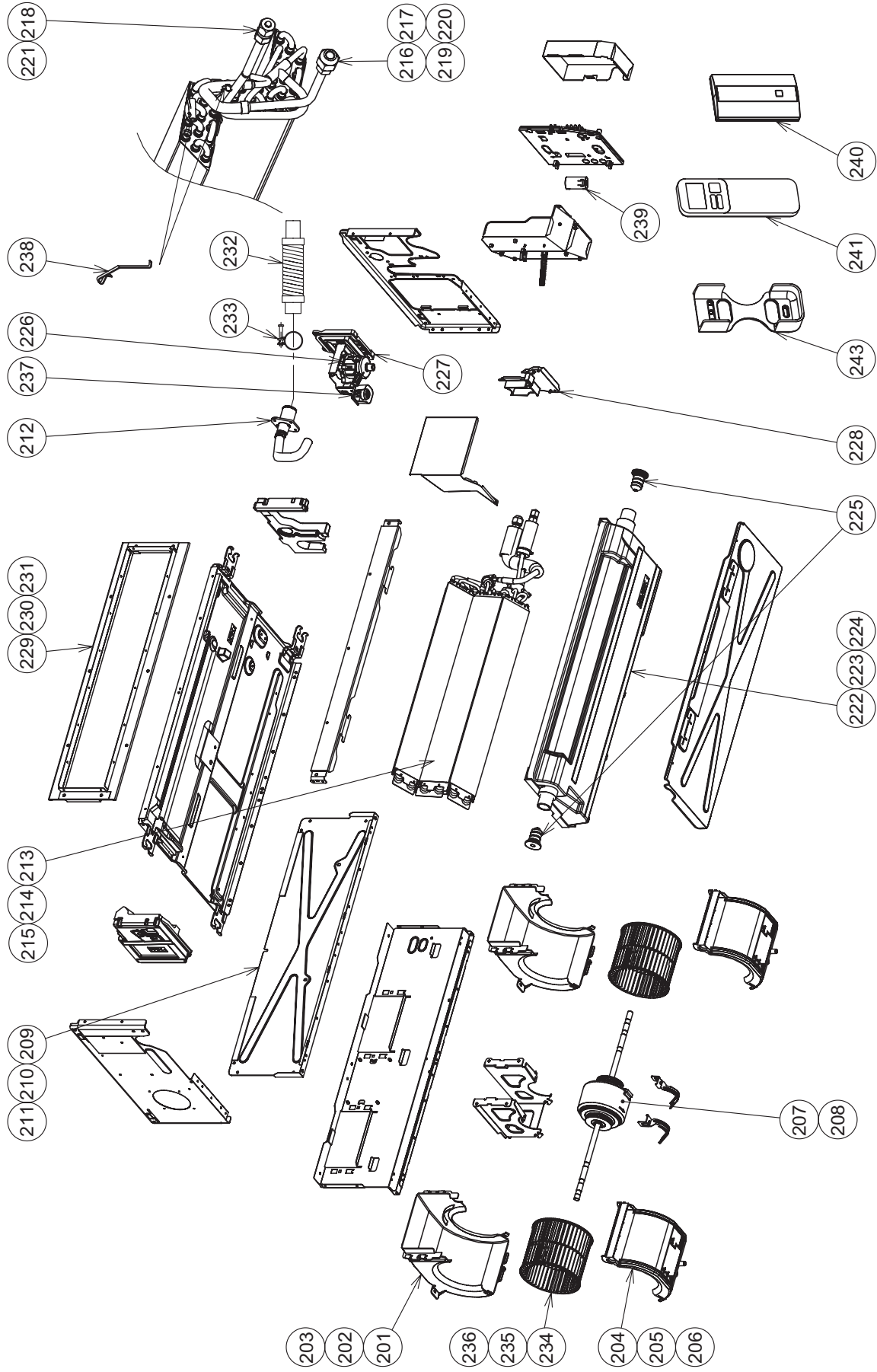
## 13-1. Indoor Unit

### R410A Model



Location No.	Part No.	Description	Q'ty/Set											
			RAS-M**G3DV-E				RAS-M**G3DV-ND				RAS-M**G3DV-TR			
			07	10	13	16	07	10	13	16	07	10	13	16
201	43H22003	CASE, FAN, UPPER	2	2	2		2	2	2		2	2	2	
202	43H22004	CASE, FAN, UPPER				2				2				2
203	43H22006	CASE, FAN, LOWER	2	2	2		2	2	2		2	2	2	
204	43H22007	CASE, FAN, LOWER				2				2				2
205	43H21004	MOTOR, FAN				1								1
206	43H21007	MOTOR, FAN					1	1	1	1				
207	43H00021	PLATE, INLET	1	1	1		1	1	1		1	1	1	
208	43H00022	PLATE, INLET				1				1				1
209	43H70001	HOSE, DRAIN	1	1	1	1	1	1	1	1	1	1	1	1
210	43H44009	REFRIGERATION CYCLE ASSY	1	1	1		1	1	1		1	1	1	
211	43H44010	REFRIGERATION CYCLE ASSY				1				1				1
212	43H49003	SOCKET	1	1	1		1	1	1		1	1	1	
213	43H49004	SOCKET				1				1				1
214	43H49006	SOCKET	1	1	1	1	1	1	1	1	1	1	1	1
215	43H49007	NUT, FLARE	1	1	1		1	1	1		1	1	1	
216	43H49008	NUT, FLARE				1				1				1
217	43H49010	NUT, FLARE	1	1	1	1	1	1	1	1	1	1	1	1
218	43H72001	PAN ASSY, DRAIN	1	1	1		1	1	1		1	1	1	
219	43H72002	PAN ASSY, DRAIN				1				1				1
220	43H79001	CAP, DRAIN	2	2	2	2	2	2	2	2	2	2	2	2
221	43H77001	PUMP, DRAIN	1	1	1	1	1	1	1	1	1	1	1	1
222	43H19006	COVER ASSY, SIDE	1	1	1	1	1	1	1	1	1	1	1	1
223	43H19007	COVER, PIPE	1	1	1	1	1	1	1	1	1	1	1	1
224	43H00024	FLANGE, OUTLET	1	1	1		1	1	1		1	1	1	
225	43H00025	FLANGE, OUTLET				1				1				1
226	43H70002	HOSE, DRAIN	1	1	1	1	1	1	1	1	1	1	1	1
227	43H79002	BAND, HOSE	1	1	1	1	1	1	1	1	1	1	1	1
228	43H20006	FAN, MULTI BLADE	2	2	2		2	2	2		2	2	2	
229	43H20007	FAN, MULTI BLADE				2				2				2
230	43H51002	SWITCH, FLOAT	1	1	1	1	1	1	1	1	1	1	1	1
231	43H47008	HOLDER, SENSOR(TC)	2	2	2	2	2	2	2	2	2	2	2	2
232	43H60006	FILTER, NOISE	1	1	1	1	1	1	1	1	1	1	1	1
233	43H58011	UNIT, SIGNAL RECEIVING	1	1	1	1	1	1	1	1	1	1	1	1
234	43H66001	REMOTE CONTROLLER, WIRELESS	1	1	1	1	1	1	1	1	1	1	1	1
235	43H66002	HOLDER, REMOTE CONTROL	1	1	1	1	1	1	1	1	1	1	1	1
236	43H21011	MOTOR, FAN	1	1	1						1	1	1	

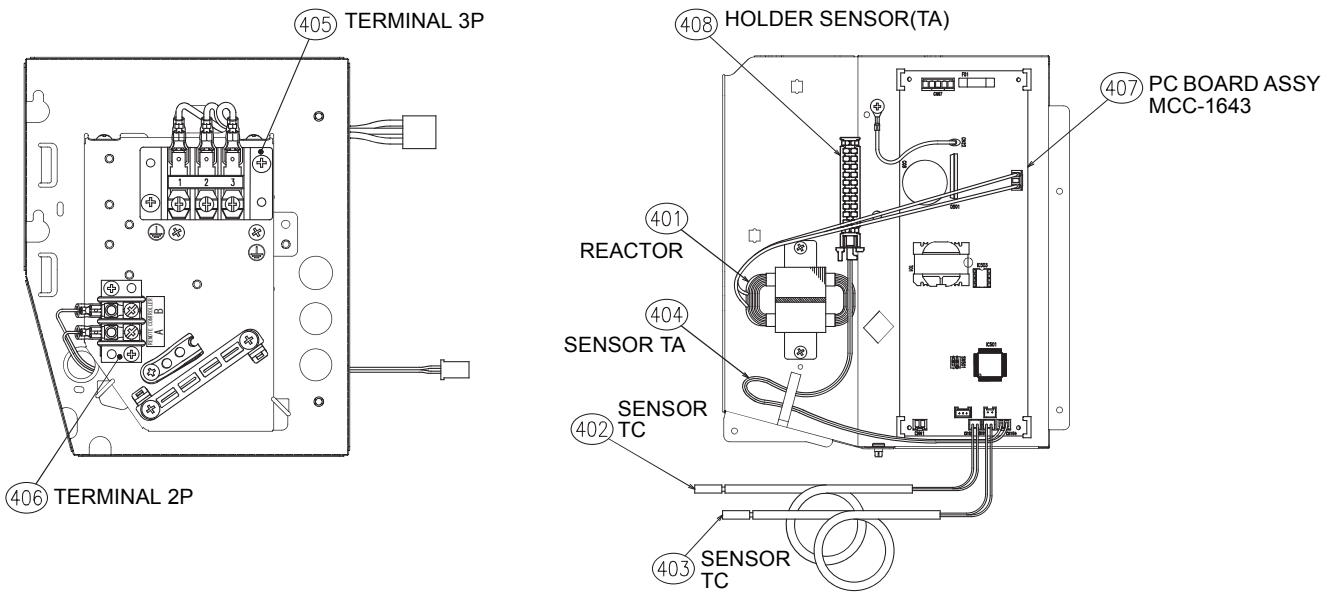
**R32 or R410A Model**





Location No.	Part No.	Description	Q'ty/Set					
			RAS-M**U2DVG-E, RAS-M**U2DVG-TR					
			07	10	13	16	22	24
201	43H22003	CASE, FAN, UPPER	2	2	2			
202	43H22004	CASE, FAN, UPPER				2		
203	43H22005	CASE, FAN, UPPER					2	2
204	43H22006	CASE, FAN, LOWER	2	2	2			
205	43H22007	CASE, FAN, LOWER				2		
206	43H22008	CASE, FAN, LOWER					2	2
207	43H21004	MOTOR, FAN				1	1	1
208	43H21011	MOTOR, FAN	1	1	1			
209	43H00021	PLATE, INLET	1	1	1			
210	43H00022	PLATE, INLET				1		
211	43H00023	PLATE, INLET					1	1
212	43H70001	HOSE, DRAIN	1	1	1	1	1	1
213	43H44018	REFRIGERATION CYCLE ASSY	1	1	1			
214	43H44019	REFRIGERATION CYCLE ASSY				1		
215	43H44020	REFRIGERATION CYCLE ASSY					1	1
216	43H49027	SOCKET	1	1	1			
217	43H49028	SOCKET				1	1	1
218	43H49029	SOCKET	1	1	1	1	1	1
219	43H49030	NUT, FLARE	1	1	1			
220	43H49031	NUT, FLARE				1	1	1
221	43H49032	NUT, FLARE	1	1	1	1	1	1
222	43H72001	PAN ASSY, DRAIN	1	1	1			
223	43H72002	PAN ASSY, DRAIN				1		
224	43H72003	PAN ASSY, DRAIN					1	1
225	43H79001	CAP, DRAIN	2	2	2	2	2	2
226	43H77001	PUMP, DRAIN	1	1	1	1	1	1
227	43H19006	COVER ASSY, SIDE	1	1	1	1	1	1
228	43H19007	COVER, PIPE	1	1	1	1	1	1
229	43H00024	FLANGE, OUTLET	1	1	1			
230	43H00025	FLANGE, OUTLET				1		
231	43H00026	FLANGE, OUTLET					1	1
232	43H70002	HOSE, DRAIN	1	1	1	1	1	1
233	43H79002	BAND, HOSE	1	1	1	1	1	1
234	43H20006	FAN, MULTI BLADE	2	2	2			
235	43H20007	FAN, MULTI BLADE				2		
236	43H20008	FAN, MULTIBLADE					2	2
237	43H51002	SWITCH, FLOAT	1	1	1	1	1	1
238	43H47008	HOLDER, SENSOR(TC)	2	2	2	2	2	2
239	43H60006	FILTER, NOISE	1	1	1	1	1	1
240	43H58011	UNIT, SIGNAL RECEIVING	1	1	1	1	1	1
241	43H66001	REMOTE CONTROLLER, WIRELESS	1	1	1	1	1	1
243	43H66002	HOLDER, REMOTE CONTROL	1	1	1	1	1	1

### 13-2. E-parts



Location No.	Part No.	Description	Q'ty/Set														
			RAS-M**G3DV-E				RAS-M**G3DV-ND				RAS-M**G3DV-TR						
			07	10	13	16	07	10	13	16	07	10	13	16			
401	43H58010	REACTOR	1	1	1	1	1	1	1	1	1	1	1	1	1	1	1
402	43H50010	SENSOR,TC	1	1	1	1	1	1	1	1	1	1	1	1	1	1	1
403	43H50011	SENSOR,TC	1	1	1	1	1	1	1	1	1	1	1	1	1	1	1
404	43H50012	SENSOR,TA	1	1	1	1	1	1	1	1	1	1	1	1	1	1	1
405	43H60013	TERMINAL,3P	1	1	1	1	1	1	1	1	1	1	1	1	1	1	1
406	43H60014	TERMINAL,2P	1	1	1	1	1	1	1	1	1	1	1	1	1	1	1
407	43H69018	PC BOARD ASSY, MCC-1643	1				1						1				
407	43H69019	PC BOARD ASSY, MCC-1643		1				1						1			
407	43H69020	PC BOARD ASSY, MCC-1643			1				1						1		
407	43H69021	PC BOARD ASSY, MCC-1643				1				1							1
408	43H63001	HOLDER,SENSOR(TA)	1	1	1	1	1	1	1	1	1	1	1	1	1	1	1

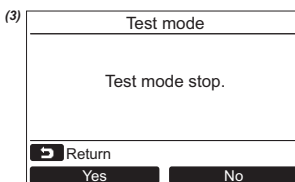
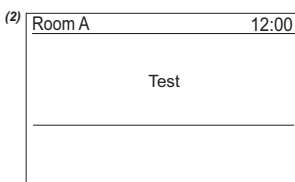
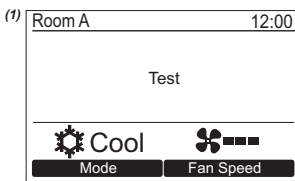
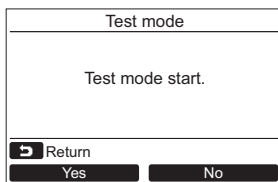
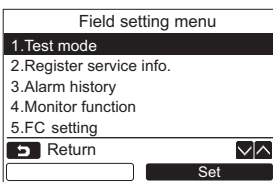
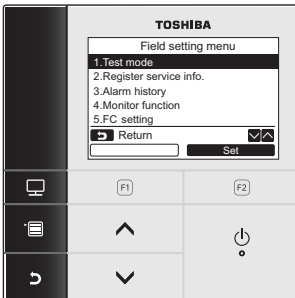
Location No.	Part No.	Description	Q'ty/Set					
			RAS-M**U2DVG-E					
			RAS-M**U2DVG-TR					
			07	10	13	16	22	24
401	43H58010	REACTOR	1	1	1	1	1	1
402	43H50010	SENSOR,TC	1	1	1	1	1	1
403	43H50011	SENSOR,TC	1	1	1	1	1	1
404	43H50012	SENSOR,TA	1	1	1	1	1	1
405	43H60013	TERMINAL,3P	1	1	1	1	1	1
406	43H60014	TERMINAL,2P	1	1	1	1	1	1
407	43H69018	PC BOARD ASSY, MCC-1643	1					
407	43H69019	PC BOARD ASSY, MCC-1643		1				
407	43H69020	PC BOARD ASSY, MCC-1643			1			
407	43H69021	PC BOARD ASSY, MCC-1643				1		
407	43H69032	PC BOARD ASSY, MCC-1643					1	
407	43H69033	PC BOARD ASSY, MCC-1643						1
408	43H63001	HOLDER,SENSOR(TA)	1	1	1	1	1	1

## 14. APPENDIX

### Lite-Vision plus Remote Controller (RB-RWS20-E/RB-RWS21-E) setup

#### 1. Test run setup

<Procedure> Perform setting while the air conditioner stops.



- 1 Push the [MENU] button to display the menu screen.
- 2 Push and hold the [MENU] button and the [DOWN] button at the same time to display the "Field setting menu".  
→ Push and hold the buttons for more than 4 seconds.

- 3 Push the [UP] / [DOWN] button to select "1. Test mode" on the "Field setting menu screen, then push the "Set" [F2] button.

→ Pushing the "Yes" [F1] button sets the test mode and the screen returns to the field setting menu screen.  
Push [CANCEL] twice, the screen (2) appears.

- 4 Push the [ON / OFF] button to start the test mode. The screen (1) shown in the left appears. (The screen (2) appears when the operation is stopped.)

→ Perform the test mode in the "Cool" or "Heat" mode.

→ Temperature setting cannot be adjusted during the test mode.

→ Check codes are displayed as usual.

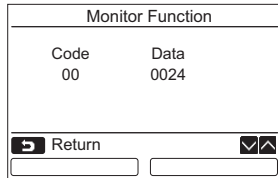
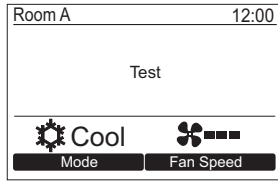
- 5 When the test mode is finished, push the [UP] / [DOWN] button to select "1. Test mode" on the "Field setting menu" screen, then push the "Set" [F2] button. The screen (3) appears.

→ Pushing the "Yes" [F1] button stops the test mode screen and continues the normal operation.

#### NOTE

The test mode stops after 60 minutes and the screen returns to the normal / detailed display.

## Using the Service monitor with the [MONITOR] button during the test mode

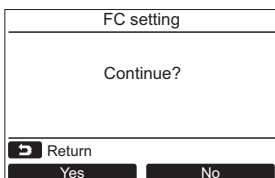
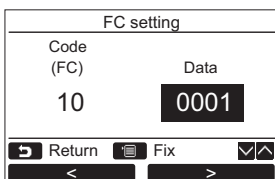
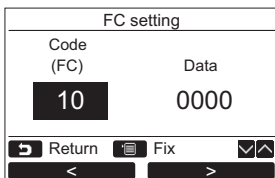
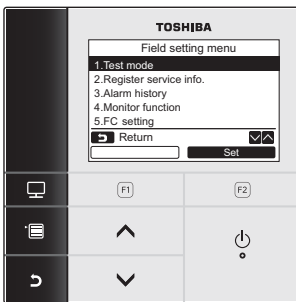


Refer to “3. Monitor function” for details.

### 2. Function selection setup

Perform the advanced settings for the air conditioner.

Carry out the setting operation while the indoor unit is stopped. (Turn off the air conditioning unit before starting the setting operation.)



Push the [MONITOR] button

- 1 Push the [MENU] button to display the menu screen.
- 2 Push and hold the [MENU] button and the [▽ ▽] button at the same time to display the “Field setting menu”.  
→ Push and hold the buttons for more than 4 seconds.
- 3 Push the [▲ ▲] / [▽ ▽] button to select “5. FC setting” on the “Field setting menu” screen, then push the “Set” [Set] [F2] button.  
→ The fan of the indoor unit operate.  
→ Move the cursor to select “Function code” with the “<” [F1] button, then set “Function code” with the [▲ ▲] / [▽ ▽] button.  
→ Move the cursor to select “data” with the “>” [F2] button, then set “data” with the [▲ ▲] / [▽ ▽] button.
- 4 Push the [MENU] button to set the other Function codes. After “Continue?” is displayed on the screen, push the “Yes” [Yes] [F1] button.
- 5 Push the “No” [No] [F2] button to finish the setting operation. “X” appears on the screen for a while, then the screen returns to the “Field setting menu” screen.  
→ Pushing the “No” [No] [F2] button displays the unit selection screen when the group control is used. Push the [CANCEL] button on the unit selection screen to finish the setting operation. “X” appears on the screen for a while, then the screen returns to the “Field setting menu” screen.

### Function selection item No. (FC) list

FC	Item	Contents		At shipment from factory												
01	Filter sign lighting time	0000: None 0002: 2500H 0004: 10000H	0001: 150H 0003: 5000H 0005: Clogging sensor used	0000: None												
02	Filter stain level	0000: Standard 0001: Heavy stain (Half of standard time)		0000: Standard												
06	Heating suction temp. shift	0000: No shift 0002: +2°C	to 0001: +1°C 0010: +10°C	0002: +2°C												
10	Type	0000: IMS duct		0000: IMS duct												
11	Indoor unit capacity	0000: Undecided	0001 to 0034	According to capacity type M07: 0001 M22: 0010 M10: 0003 M24: 0011 M13: 0005 M16: 0007												
17	Cooling suction temp. shift	0000: No shift 0002: +2°C	to 0001: +1°C 0010: +10°C	0000: No shift												
1E	In automatic cooling/heating, temp. width of cool → heat, heat → cool mode selection control point	0000: 0 deg (Cool/heat are reversed with ± (Data value) / 2 against the set temperature)	to 0010: 10 deg	0003: 3 deg (Ts±1.5)												
28	Automatic reset of power failure	0000: None	0001: Provided	0000: None												
32	Sensor selection	0000: Body TA sensor	0001: Remote controller sensor	0000: Body sensor												
5d	External static pressure	<table border="1"> <thead> <tr> <th>SET DATA</th> <th>External static pressure</th> </tr> </thead> <tbody> <tr> <td>0000</td> <td>Depends on DIPSW 501-1,-2</td> </tr> <tr> <td>0001</td> <td>10 Pa</td> </tr> <tr> <td>0002</td> <td>20 Pa</td> </tr> <tr> <td>0003</td> <td>35 Pa</td> </tr> <tr> <td>0004</td> <td>45 Pa</td> </tr> </tbody> </table>		SET DATA	External static pressure	0000	Depends on DIPSW 501-1,-2	0001	10 Pa	0002	20 Pa	0003	35 Pa	0004	45 Pa	0000: Depends on DIPSW 501-1,-2
SET DATA	External static pressure															
0000	Depends on DIPSW 501-1,-2															
0001	10 Pa															
0002	20 Pa															
0003	35 Pa															
0004	45 Pa															

### 3. Monitor function

The sensor temperature or operational status of indoor unit, outdoor unit, or remote controller can be monitored.

- 1 Push the [▲ ▲] / [▼ ▼] button to select "4. Monitor function" on the "Field setting menu" screen, then push the "Set" [F2] button.

→ Push the [▲ ▲] / [▼ ▼] button to select the code to check data.

- 2 Push the [C] CANCEL button to return to the "Field setting menu" screen.

	Item code	Data name	Unit
Indoor unit data	01	Room temperature (Remote controller)	°C
	02	Indoor suction temperature (TA)	°C
	03	Indoor heat exchanger (Coil) temperature (TCJ)	°C
	04	Indoor heat exchanger (Coil) temperature (TC)	°C
	* 07	Indoor fan revolution frequency	rpm
	* F2	Indoor fan calculated operation time	×100h
	F3	Filter sign time	×1h
	* F8	Indoor discharge temperature*1	°C

	Item code	Data name	Unit
Outdoor unit data	60	Outdoor heat exchanger (Coil) temperature (TE)	°C
	61	Outside temperature (TO)	°C
	62	Compressor discharge temperature (TD)	°C
	63	Compressor suction temperature (TS)	°C
	6A	Operation current (× 1/10)	A
	70	Compressor operation frequency	rps
	72	Outdoor fan revolution frequency (Lower)	rpm
F1	Compressor calculated operation time	×100h	

## 4. Alarm history

The error contents in the past can be called.

Field setting menu	
1. Test mode	
2. Register service info.	
<b>3. Alarm history</b>	
4. Monitor function	
5. FC setting	
Return	Set

Alarm history				
	Unit	Code	Date	Time
1.	1-1	OB	31/12/2010	12:25
2.	-	-	-	-
3.	-	-	-	-
4.	-	-	-	-
Return				Reset

### Deleting the alarm history

Alarm history	
Reset all alarm data.	
Return	
Yes	No

- 1 Push the [ ] / [ ] button to select "3. Alarm history" on the "Field setting menu" screen, then push the " Set" [ F2] button.

List of latest 10 Alarm data is displayed.

\* The oldest data are deleted in order to record the new ones.

→ The date and time when the error occurred for the first time is displayed for the repeated alarm.

- 1 Push the " Reset" [ F2] button while the list of alarm history is displayed.

- 2 Push the " Yes" [ F1] button after the confirmation screen is displayed.

→ Delete the alarm history in each remote controller when the dual remote controller system is used.

## **Toshiba Carrier Air Conditioning (China) Co., Ltd.**

**Building 1, No.60, 21st Avenue and 2nd Floor,  
Building 3, No.235, 23st Avenue, Baiyang Street,  
Hangzhou Economic and Technological Development Area, China**

### Revision record

First issue	—	—	Sep.2014
Revision 1	Change of knockout hole diameter	Page 14	Mar.2015
Revision 2	Drain pan assy changes	P14,49,51,55,85	Oct.2017
Revision 3	R32 model adds R32 refrigerant description of content adds	—	Mar.2018
Revision 4	R32 model's remote controller changes	P100	Nov.2018
Revision 5	1. RAS-M07~13G3DV-E/TR, RAS-M07~13U2DVG-E/TR changes the maintenance motor from 94w to 50w. 2. RAS-M22~24U2DVG-E/TR power supply changes.	P11,P98,P100	Jun.2020